



# Tranquility<sup>®</sup> 30 Digital (TE) Series

TWO-STAGE  
HORIZONTAL VERTICAL AND DOWNFLOW  
EARTHPURE<sup>®</sup> SYSTEMS SIZES 026-072



## Table of Contents

What's New With The Tranquility® 30?.....	3	Physical Data.....	37
iGate® 2 Communicating Controls.....	4	Dimensions—Vertical Upflow .....	38-39
vFlow® Internal Variable Water Flow Control.....	5	Dimensions—Vertical Downflow .....	40-41
How to Use this Catalog.....	6-7	Dimensions—Horizontal .....	42-43
Design Features.....	8-9	Electrical Data.....	44
Unit Model Key.....	10	Standard Electrical Wiring Diagrams.....	45-47
AHRI/ISO/ASHRAE 13256-1 .....	11	ECM Blower Control.....	48
Reference Calculations & Legend.....	12	Blower Performance Data.....	49
Full Load Correction Factors.....	13	ClimaDry® Benefits.....	50-51
Part Load Correction Factors.....	14	ClimaDry® Operations.....	52-53
Correction Tables.....	15	Accessories, Options, and Warranty.....	54
Performance Data Selection Notes.....	16	Revision History .....	56
Performance Data .....	17-36		

## What's New with ClimateMaster's Tranquility® 30 Digital?

**ClimateMaster has invested years of experience, research and development into new technologies that set the Tranquility® 30 Digital systems apart from the rest by delivering higher cost savings, more reliability and unparalleled comfort.**

### High Efficiency = Low Operating Cost

The Tranquility® 30 Digital with vFlow® variable water flow technology breaks new ground in efficiency by approaching 30 EER part load cooling and 4.8 COP part load heating for ground loop applications. Leveraging the next generation Copeland scroll compressor, variable speed ECM motor, low-pressure-drop water-to-refrigerant heat exchanger and vFlow variable water flow technology, the Tranquility 30 has been optimized for maximum operating efficiency and the industry's lowest operating cost. The Hot-Water Generator further increases operating cost savings by pre-heating hot water for domestic use. Bottom-line, the Tranquility 30 delivers the industry's lowest operating cost.

### iGate® 2—Communicating Controls

iGate® 2 technology represents the next generation in intelligent controls by using 2-way communication to provide a gateway into the system. The iGate 2 control system allows the homeowner and dealers to monitor the performance of the unit, custom tailor its operation, and diagnose any issues, all from the communicating thermostat.

The iGate 2 communications hub is the new DXM2.5 intelligent controller, which analyzes the status of sensors and smart components (also 2-way communicating) to determine how best to operate your system for optimal comfort, efficiency and long-term reliability. All of this information is passed to the iGate 2 thermostat (or dealer diagnostic tool), where it can be displayed in plain English. And since communication is both ways, the iGate 2 thermostat can also be used to configure and tailor the system without touching your unit.

Future accessories will enable iGate 2 communication over the internet, allowing the homeowner (and dealer if the homeowner chooses) to access the system from a PC or smart phone.

### vFlow® Variable Water Flow

vFlow variable water flow technology is a major advance in geothermal system performance made possible through the iGate 2 system. vFlow not only builds the major water circulation components right into the unit for a faster and cleaner installation, it also intelligently varies the water flow to minimize pump energy consumption and improve the reliability of the system.

The heart of vFlow is either a variable-speed pump (for ground loops) or modulating water valve (for groundwater) directly linked into the iGate 2 system. Water flow is automatically varied based on changes in unit capacity level (stage) and source water temperature

to maintain optimum system performance.

vFlow systems reduce water pumping power consumption by 60–80% compared to traditional external pumping modules, which can save over \$100 per year in an average 2,000 square foot home. In addition, vFlow protects the unit against extreme operating conditions, extending the life of the compressor and air coil. Since vFlow is built right inside the unit, it also saves on installation time and makes for a very clean and compact installation.

### Microchannel Air Heat Exchanger – The Next Generation in Air Coils

ClimateMaster also utilizes the Microchannel air heat exchanger on the 026 to 049 sizes in the Tranquility 30 Digital family. Microchannel aluminum heat exchangers offer higher heating efficiency and have been used for years in automotive applications. ClimateMaster is the first geothermal company to field test and use Microchannel Air Heat Exchangers.



### ENERGY STAR® Most Efficient – Communicating AND Efficient

Tranquility 30 Digital has been recognized as Most Efficient by ENERGY STAR for exceeding stringent efficiency requirements AND for meeting smart communication requirements. With these systems the customer is getting an EFFICIENT system and an INTELLIGENT system—buying a system can't get SMARTER than that!

### Easy to Install, Easy to Service—A Technician's Dream Machine

Installations are easier and quicker with Tranquility 30 Digital units with (1) vFlow built-in water flow vs. bulky external flow controllers / water flow components (2) iGate 2 system configuration (airflow, water ΔT, accessories) on the thermostat and (3) iGate 2 Manual Operation from thermostat at start up to verify proper operation.

Service is even easier with (1) iGate 2 Service Warning on the thermostat for homeowners to call the dealer with fault information (2) iGate 2 Service Mode for dealers to see conditions (temperature, flow, input/output, configuration) at the time of fault, for better, quicker diagnosis (3) Easy Access to components with swing-out control board, easy-access panels, refrigerant/ water pressure Schrader ports at the front of the unit.

ClimateMaster has designed and built the EASIEST geothermal unit to install and service, period.



## iGate® 2 Communicating Controls

### iGate® 2 Information gateway to monitor, control and diagnose your system

The Tranquility® 30 Digital is equipped with industry-first, iGate® 2 – Information Gateway – a 2-way communicating system that allows users to interact with their geothermal system in plain English AND delivers improved reliability and efficiency by precisely controlling smart variable speed components. iGate 2 makes the Tranquility Digital series the easiest geothermal products to install and service.

#### Monitor/Configure

Installers can configure Tranquility 30 Digital units from the thermostat, including: Air flow, loop  $\Delta T$ , water-flow option configuration, unit configuration, accessory configuration, and demand reduction (optional, to limit unit operation during peak times). Users can look up the current system status: temperature sensor readings and operational status of the blower and pump.

#### Precise Control

The new DXM2.5 board enables intelligent, 2-way communication between the DXM2.5 board and smart components like the communicating thermostat, fan motor, and water pump. The DXM2.5 control can also directly control the modulating valve and accepts various feedback/input. The Intelligent DXM2.5 board uses information received from the smart components and sensors to precisely control operation of the variable-speed fan and variable-speed water pump (or modulating valve) to deliver higher efficiency, reliability and increased comfort.

#### Diagnostics

iGate 2 takes diagnosing geothermal units to the next level of simplicity, by providing a dashboard of system and fault information, in plain English, on the iGate 2 thermostat/ service tool.

iGate 2 Service Warning warns the homeowner of a fault and displays dealer information (if programmed), fault descriptions, possible causes and current system status (temperature readings, fan RPM and water flow status) to provide to a dealer on the phone.

In iGate 2 Service Mode, the service personnel can access fault descriptions, possible causes and most importantly, the conditions (temp, flow, i/o conditions, configuration) at the time of the fault and at the time of the call. Manual Operation mode allows the service personnel to manually command operation for any of the thermostat outputs, blower speed, as well as pump speed or valve position from the thermostat, to help troubleshoot specific components.

With the iGate 2 communicating system, consumers and contractors have a gateway to system information never before available.

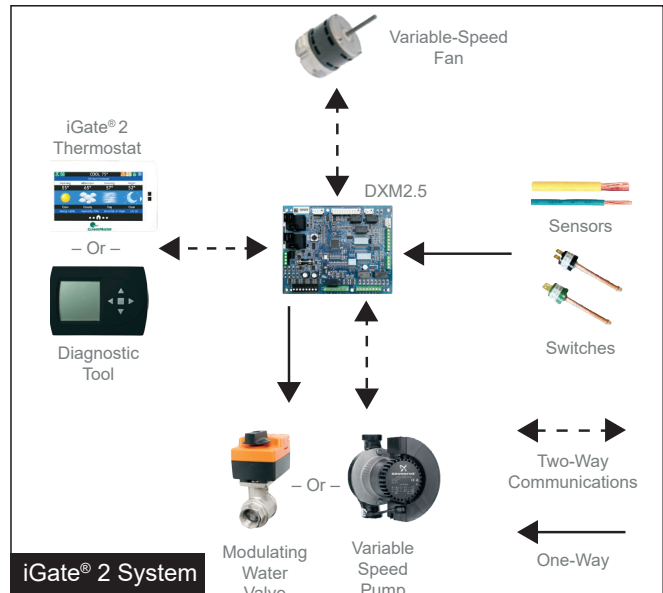

AIRFLOW SELECTION	
	CFM
HEAT STAGE 1	600
HEAT STAGE 2	750
AUXILIARY HEAT	850
EMERGENCY HEAT	850
COOL STAGE 1	525
COOL STAGE 2	700
COOL DEHUMID 1	425
COOL DEHUMID 2	550
CONTINUOUS FAN	350
HEAT OFF DELAY	60
COOL OFF DELAY	30
◀ PREVIOUS	NEXT ▶

POSSIBLE FAULT CAUSES	
LOW WATER COIL TEMP	
LOW WATER TEMP - HTG	
LOW WATER FLOW - HTG	
LOW REFRIG CHARGE - HTG	
INCORRECT LT1 SETTING	
BAD LT1 THERMISTOR	
◀ PREVIOUS	

FAULT TEMPERATURE CONDITIONS	
LT1 LOW WATER TEMP	
HEAT 1 11:11 AM 11/14	
LT1 TEMP	28.1
LT2 TEMP	97.3
HOT WATER EWT	121.5
COMP DISCHARGE	157.7
LEAVING AIR	92.7
LEAVING WATER	34.9
ENTERING WATER	42.1
CONTROL VOLTAGE	26.4
◀ PREVIOUS	



## vFlow® Internal Variable Water Flow Control

### vFlow® Internal Variable Water Flow

Industry-first, built-in vFlow® replaces a traditionally inefficient, external component of the geothermal system (water circulation) with an ultra-high-efficient, variable speed, internal water flow system. This saves homeowners 70-80% on operating water circulator vs traditional single speed pump systems. It saves installers time and labor by avoiding installing bulky external flow centers or flow regulators. Multi-unit installations are also much simpler with vFlow systems, as the units automatically adjust water flow across the system.

vFlow is enabled by iGate® 2, which facilitates intelligent communication between the thermostat, DXM2.5 control, sensors and internal water pump/valve to make true variable water flow a reality.



### vFlow® is available for three applications:

- 1) Closed loop – individual unit pumping: vFlow Internal Flow Controller model "1" (standard head) or "2" (high head) ("2" in Position 11 of the unit model number) would be used. This includes variable speed pump, flushing ports, 3 way flushing valves and expansion tank. Copper water coil is standard with this option.
- 2) Closed loop – multi unit / central pumping: vFlow Internal Low Pressure Drop (high Cv) Motorized Modulating Valve ("5" in Position 11 of the unit model number) would be used. Copper water coil is standard with this option.
- 3) Open loop: vFlow Internal Motorized Modulating Valve ("6" in Position 11 of the unit model number) would be used. Cupro-Nickel water coil is standard with this option. Valves in open loop models have higher pressure drop than the valves in the closed loop (modulating valve) models for better flow control when used in systems with higher pressure water supply pumps, and are not recommended for closed loop applications.

### vFlow® delivers three main benefits:

- 1) Easier and quicker unit installation as the flow control is built in to the unit.
- 2) Superior reliability by varying the water flow to deliver more stable operation.
- 3) Higher cost savings by varying the flow (and pump watt consumption) to match the unit's mode of operation.

### Internal components

Tranquility® 30 can be installed more easily and compactly than its predecessors because water-flow components are internal to the unit. It also saves installing contractors labor and time by eliminating the need for an external flow regulator or a bulky external pumping module.

### Variable flow

vFlow technology enables variable water flow through the unit, with the DXM2.5 control adjusting the pump speed to maintain an installer-set loop  $\Delta T$ . By controlling the water flow, the system is able to operate at its optimal capacity and efficiency. vFlow provides a lower flow rate for part load where units typically operate 80% of the time and a higher, more normal flow rate for full load operation.

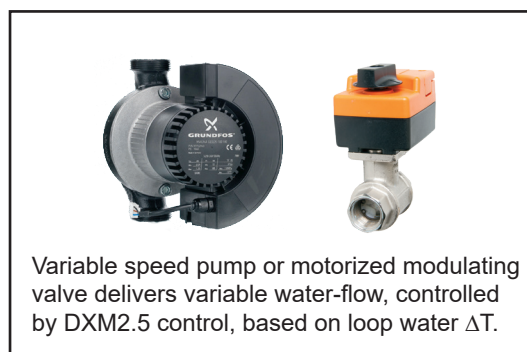

### Energy Savings with water circulation control

Units with vFlow deliver higher operating cost savings by varying the water flow to match the unit's operation (ex: lower water flow when unit is in part load operation). Lowering the flow results in lower energy consumption by the water pump (=higher cost savings) in vFlow units (whether internal or external pump).

In closed loop applications, using vFlow with an internal variable-speed (ECM) flow controller, the ECM pump uses fewer watts than a fixed speed (PSC) pump, even at full load (see chart). The ECM pump excels in energy savings in part load, saving 70-80% watts compared to fixed speed pumps (see chart). The ECM pump can operate with independent flow rates for heating and cooling, further saving even more energy.

In open loop applications, when the motorized modulating valve slows down the water flow during part load operation, the external pump consumes fewer watts, thus saving more energy.

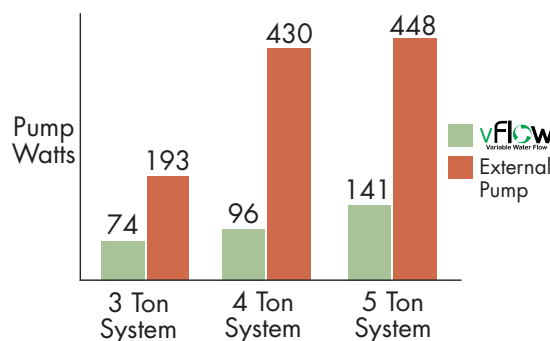

## How to Use this Catalog

As with any unit selection the first step is to perform a proper load calculation. Once the design cooling and heating loads are known the predominant load can be used to select the appropriate unit. In northern climates the heating load may be used to select the unit, whereas in southern climates the cooling load may be used. Likewise, the anticipated maximum EWT should be used for the cooling mode and the minimum anticipated EWT should be used when selecting for the heating mode. These EWTs may be the same temperature in the case of a ground water application.

Use the Full Load performance pages to select the unit size. Once the unit size is determined read the associated flow rate (gpm) for the needed capacity. Typically this is 1.5 – 2 gpm/nominal ton for ground water applications and 2.25 – 3 gpm/ton for ground loop applications.

### For Closed Loop Applications

For closed loop systems where an internal circulating pump is desired, the TE30 units can be ordered with an internal, variable speed loop circulator. This would typically be for a ground loop or secondary pumping application. The internal loop circulator is available in a high head version for all unit sizes and in a standard head version for unit sizes 026 and 038. Units with the standard head pump should not be combined with units with high head pumps on the same loop. Standard head pumps are best suited for small applications with a single unit. The maximum possible pump curve is shown in the tables below. The pumps can also operate at any point below the curve as a “partial load” pumping condition. The designer/installer should use the information presented in this catalog to determine the available pump head for any external piping/accessories and ground loop (if applicable). This can be done in the following manner:

1. Determine the desired flow rate through the TE30 from the performance pages (as described above). Read the associated pressure drop in feet of head for the worst case condition (lowest anticipated entering water temperature) at the required flow rate.
2. Determine the maximum pump head from the pump curve associated with the required flow rate from step 1.
3. Subtract the unit pressure drop (from step 1) from the maximum available pump head (from step 2).
4. The remainder is the available pump head to overcome any external piping/accessories and the ground loop.

If the available pump head is equal to or greater than the calculated external piping and loop pressure drop, no other steps are required. If the available pump head is less than the calculated pressure drop of all external piping and the loop, then changes to the loop design should be considered.

Typically residential loops consist of ¾” circuit piping and 1 ¼” supply and return piping. If the available pump head is less than the calculated pressure drop of all external piping and the loop, it is recommended that larger pipe sizes be investigated such as 1” circuit piping and/or 1 ½” or 2” supply and return piping. This will significantly reduce system pressure drop with little change in Reynolds number. If this causes the Reynolds number to fall to an unacceptable level, try reducing the overall number of circuits. This will increase the flow rate through each circuit, increasing the Reynolds number.

Another solution might be to allow the system flow rate to be reduced. Typical geothermal flow rates are between 2.25 and 3 gpm/ton. As long as the system flow rate using the internal variable speed circulator is at or above 2.25 gpm/ton it is safe to operate the system. A quick review of the unit performance tables will show that this causes very little change in unit performance.

ClimateMaster’s Pressure Drop Software can be used in conjunction with the pump performance information presented here to determine actual flow rate when the internal circulator is not able to provide the desired design flow rate.

### Standard Head Variable Pump

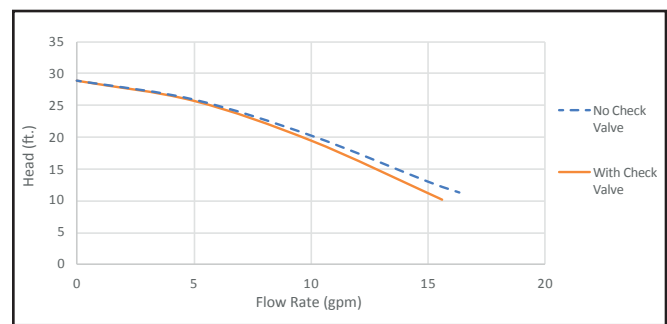

### High Head Variable Pump

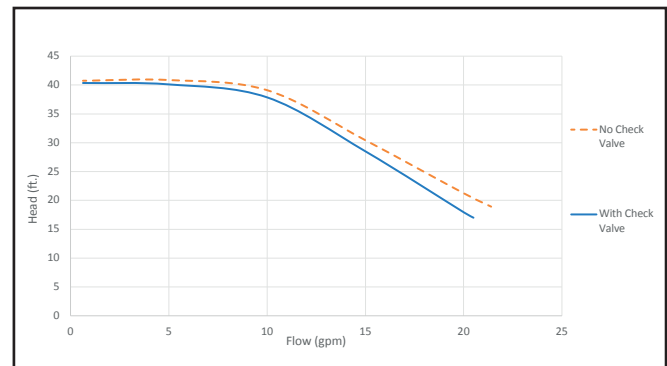



## How to Use this Catalog

For secondary pumping applications follow the above steps except do not consider the pressure drop of the loop. The internal 25-140 circulator will only need to overcome the pressure drop of the unit and any piping connecting the unit to the primary loop.

The TE30 can also be ordered with an internal modulating water control valve for closed loop systems with multiple units and a central pump. In this case the modulating water valve will stop water flow through the unit when the unit is not operating and control the flow rate through the unit during operation, saving pumping energy in both cases.

When using an internal modulating water valve the central pump must be able to overcome the pressure drop of the valve in addition to the pressure drop of the unit. Because of this, internal modulating valves for closed loop systems are designed with a low pressure drop in mind. The minimum pressure drop for the internal closed loop valve is shown in the 'Modulating Valves for Closed Loop Applications' table below. This pressure drop should be added to the unit pressure drop when determining system pressure drop for central pump selection.

### For Open Loop Applications

The TE30 can also be ordered with the internal modulating water control valve for open loop systems with an external well pump. In this case the modulating water valve will stop water flow through the unit when the unit is not operating and act as a flow control device to control the flow rate through the unit during operation.

When using an internal modulating water valve the external pump must be able to overcome the minimum pressure drop of the valve in addition to the pressure drop of the unit. The minimum pressure drop for the open loop internal valve is shown in the 'Modulating Valves for Open Loop Applications' table below. This pressure drop should be added to the unit pressure drop when determining overall equipment pressure drop.

### Modulating Valves for Closed Loop Applications

TE026		
Valve Cv = 4.7		
60°F Water		
GPM	Valve ΔP @ GPM (psi)	Valve ΔP @ GPM (ft hd)
2.0	0.181	0.4
3.0	0.407	0.9
4.0	0.724	1.7
5.0	1.132	2.6
6.0	1.630	3.8

TE038		
Valve Cv = 7.4		
60°F Water		
GPM	Valve ΔP @ GPM (psi)	Valve ΔP @ GPM (ft hd)
3.0	0.2	0.4
4.0	0.3	0.7
5.0	0.5	1.1
6.0	0.7	1.5
7.0	0.9	2.1
8.0	1.2	2.7
9.0	1.5	3.4

TE049		
Valve Cv = 10		
60°F Water		
GPM	Valve ΔP @ GPM (psi)	Valve ΔP @ GPM (ft hd)
4.0	0.2	0.4
5.0	0.3	0.6
6.0	0.4	0.8
7.0	0.5	1.1
8.0	0.6	1.5
9.0	0.8	1.9
10.0	1.0	2.3
11.0	1.2	2.8
12.0	1.4	3.3

TE064 & 072		
Valve Cv = 19		
60°F Water		
GPM	Valve ΔP @ GPM (psi)	Valve ΔP @ GPM (ft hd)
6.0	0.1	0.2
7.0	0.1	0.3
8.0	0.2	0.4
9.0	0.2	0.5
10.0	0.3	0.6
11.0	0.3	0.8
12.0	0.4	0.9
13.0	0.5	1.1
14.0	0.5	1.3
15.0	0.6	1.4
16.0	0.7	1.6
17.0	0.8	1.8

### Modulating Valves for Open Loop Applications

TE026, 038 & 049		
Valve Cv = 4.7		
60°F Water		
GPM	Valve ΔP @ GPM (psi)	Valve ΔP @ GPM (ft hd)
2.0	0.2	0.4
3.0	0.4	0.9
4.0	0.7	1.7
5.0	1.1	2.6
6.0	1.6	3.8
7.0	2.2	5.1
8.0	2.9	6.7
9.0	3.7	8.5
10.0	4.5	10.5
11.0	5.5	12.7
12.0	6.5	15.1

TE064 & 072		
Valve Cv = 7.4		
60°F Water		
GPM	Valve ΔP @ GPM (psi)	Valve ΔP @ GPM (ft hd)
6.0	0.7	1.5
7.0	0.9	2.1
8.0	1.2	2.7
9.0	1.5	3.4
10.0	1.8	4.2
11.0	2.2	5.1
12.0	2.6	6.1
13.0	3.1	7.1
14.0	3.6	8.3
15.0	4.1	9.5
16.0	4.7	10.8
17.0	5.3	12.2

## Tranquility® 30 Design Features

The Tranquility® 30 Digital Series has abundant features and ultra-high efficiency.

### Application Flexibility

- Five Capacities 026, 038, 048, 064, and 072
- Entering water temperature operation range (20-120°F EWT) and flow rates as low as 1.5 gpm per ton
- Two-stage upflow, downflow, and horizontal right or left return
- Internal (upflow and downflow only) electric heat unit (optional) designed for easy field installation.
- Optional external (horizontal units) electric heat unit designed for easy field installation
- Field selectable low-temperature protection settings for GWHP or GLHP installations
- Standard pre-installed 2" filter frame with 2" high performance MERV 11 pleated air filter
- Optional Integrated vFlow® functionality for most geothermal applications

### Operating Efficiencies

- Exceeds ASHRAE 90.1 and Energy Star Tier 3 efficiency levels
- Energy Star® Most Efficient
- EarthPure® HFC-410A zero ozone depletion refrigerant.
- Rugged and highly efficient next generation Copeland UltraTech™ 2-stage scroll compressors provide ultra-high efficiencies and unsurpassed comfort.
- Optional hot water generator with advanced control logic and internally mounted pump.
- Oversized coaxial tube water-to-refrigerant heat exchangers operate at low liquid pressure drop. Convoluted copper (and optional cupro-nickel) water tube functions efficiently at low-flow rates and provides low-temperature-damage resistance.
- Oversized tin plated, rifled tube/lanced aluminum fin, air to refrigerant heat exchangers provide high efficiency at low face velocity (064 and 072)
- Next generation all aluminum microchannel air coil (026, 038, 049) for high efficiency
- Large low RPM blowers with variable speed ECM fan motors provide quiet, efficient air movement with high static capability. Installer selectable ECM air flow provides the ultimate in comfort optimization.

### Service & Installation Advantages

ClimateMaster's Tranquility® 30 Digital series incorporates features that are industry firsts, which make it extremely easy to install:

- Ease of installation:
  - 1) vFlow® - with the industry exclusive features, these units are ready to install out of the box with no requirement for external pumps, expansion tanks, or valves for the ground loop removing a lot of the complexity of installation.
  - 2) Full digital controls that communicate with the thermostat which allows all unit configuration from the thermostat...the easiest installation setup for any level of installer. Far simpler than the use of dip-switches on the unit control board.
- Tranquility® 30 only requires 4 wires between the communicating thermostat and the unit. Others require up to 9 or 14 wires for full functionality. This is achieved by leveraging the full power of the microprocessor on the control.
- Internal variable speed circulator includes an internal check valve for multiple unit/ shared loop installations.
- Optional SecureStart™ can expand the life of your unit by reducing start up current (just 30% of normal amps) and protect the compressor from potentially damaging low-voltage sags.

- Standard cornerpost schrader ports provide access to source pressure drop across unit coaxial heat exchanger.
- The communicating DXM2.5 control board diagnostic and communicating thermostat features allow the home owner to tell the service technician what is wrong with the unit before the technician leaves the shop.
- The two-section swing-out and removable control box design provides wide-open service access to the compressor section. Multiple unit access panels allow technicians to access any side of the cabinet. Service friendly highly accessible high/low refrigerant pressure ports are located on a service bracket at the front of the unit. No other product / manufacturer in the geothermal segment offer this convenience.
- An innovative two-section electrical control box design that tucks the stationary line voltage components safely behind a swing-out low voltage control panel to provide clear service access through the front of the unit. The low voltage panel can even be quickly pulled off the hinges and removed. Harness connections make controller replacement a snap.
- ¾" MPT condensate connection directly from condensate drain pan eliminates internal plastic drain tubing that is subject to clogging and avoids the need for a fitting that reduces the drain opening size.
- Diagnostic display of system inputs, outputs, and configuration settings at thermostat or Configuration/Diagnostic tool.
- Diagnostic display of system temperatures at thermostat (AWC99U\*\*):
  - Geo source in and out
  - Compressor discharge line
  - LT1 and LT2 Refrigerant Line Temperature Sensors
  - Leaving air
  - Entering potable hot water to HWG
- Immediate manual control of all DXM2.5 outputs is available at the thermostat (AWC99U\*\*) or Configuration/Diagnostic tool (ACDU\*\*) for rapid troubleshooting.
- Expansion tank eliminates "flat loop" callbacks by working to maintain steady loop pressure.
- Brass swivel geo and hot water connections for quick connection and elimination of wrenches or sealants during installation.
- Intelligent fault retry with history retention.
- Two configurable auxiliary relays for low voltage control of accessories.
- UPS (Unit Performance Sentinel) provides early warning of inefficient operation.
- Optional service disconnect switch located in the front panel for easy service access.

### Factory Quality & Industry Certifications

All units are built and factory run tested on our Integrated Process Control Assembly System (IPCS). The IPCS is a unique state of the art manufacturing system that is designed to assure quality of the highest standards of any manufacturer in the water-source industry. Our IPCS system:

- Verifies that the correct components are being assembled.
- Automatically performs special leak tests on all joints
- Conducts pressure tests
- Performs detailed run test
- Automatically disables packaging for a "failed" unit
- Creates computer database for future service analysis and diagnostics from run test results
- All refrigerant brazing is done in a nitrogen atmosphere
- All units are deep evacuated to less than 100 microns prior to refrigerant charging



## Tranquility® 30 Design Features

- All joints are both helium and halogen leak tested to ensure annual leak rate of less than ¼ ounce
- AHRI/ASHRAE/ANSI/ISO 13256-1 certified.
- ETL listed.
- US EPA “Energy Star” Tier 3 compliant.

### Advanced Controls

iGate® 2 communicating control provides advanced unit functionality and comprehensive configuration, monitoring and diagnostic capabilities through digital communication links with the variable-speed fan motor, variable-speed source pump (or modulating valve) and communicating thermostat or Configuration/Diagnostic tool.

- 7 temperature sensor inputs for system protection and control
- Anti-short cycle and over/under voltage protection
- High pressure, loss of charge, and condensate overflow protection
- LED fault and status indication at controller
- Service tool port for optional setup and diagnostics at unit

### Factory Options and Accessories

- Hot water generator with internally mounted pump and advanced logic control
- SecureStart module can expand the life of the unit by reducing start up current and protecting the compressor from low-voltage conditions.
- Electrical Service Disconnect Switch located on the unit front panel for ease of service.

### Field Installed Accessories

- iGate® 2 Communicating, Programmable Thermostat (AWC99U\*\*)
- Auxiliary Electric Heater
- Earthpure® Polarized Media Electric Air Cleaner
- Configuration / Diagnostic Tool (ACDU\*\*)
- Outdoor/Remote Temperature Sensor (AST008)
- Anti Scald Valve (AVAS4)
- Secure Start Compressor Soft Start Kit (13B0045N01)
- Unit Vibration Isolation Pad
- Unit Stand
- Secondary Drain Pan (Horizontal Units)

### Warranty

- ClimateMaster residential class heat pumps are backed by a ten-year limited warranty on all unit parts, including the following accessories when installed with ClimateMaster units: Flow Controllers, Thermostats & Electric Heaters.
- ClimateMaster goes even further to back up its commitment to quality by including a service labor allowance for the first five years on unit parts and thermostats, auxiliary electric heaters and geothermal pumping modules.
- The Optional Extended Factory Service Labor Allowance Warranty offers additional length of term protection to the consumer by offsetting service labor costs for 10 years.

- 1 Exclusive iGate® 2 Two-Way Communicating Control to configure, monitor and diagnose AT THERMOSTAT
- 2 Optional vFlow® Internal Variable Water Flow System with Internal Flow Center or Internal Motorized Modulating Valve for optimized efficiency and reliability
- 3 Next generation Copeland™ Ultra-Tech™ Two-Stage Scroll Compressor with dual-level isolation for ultra-quiet and high-efficiency operation
- 4 Emerson UltraTech® Variable-Speed Communicating Fan Motor with soft start and constant CFM control
- 5 Tin-Plated Copper or all aluminum microchannel Air Coils to resist formicary corrosion
- 6 Foil-Faced Insulation in the blower section and fully insulated compressor section conform to ASHRAE 62 specifications
- 7 Two-inch high-efficiency MERV 11 Filter (standard) or EarthPure® Air Cleaner for high quality indoor air
- 8 Two-Section Swing-out Control Box design provides wide-open service access
- 9 Refrigerant Schrader Ports Located on bracket at the front access panel for easy service access
- 10 Water Schrader Ports located on corner post to easily read pressure drop across water heat exchanger for easy troubleshooting

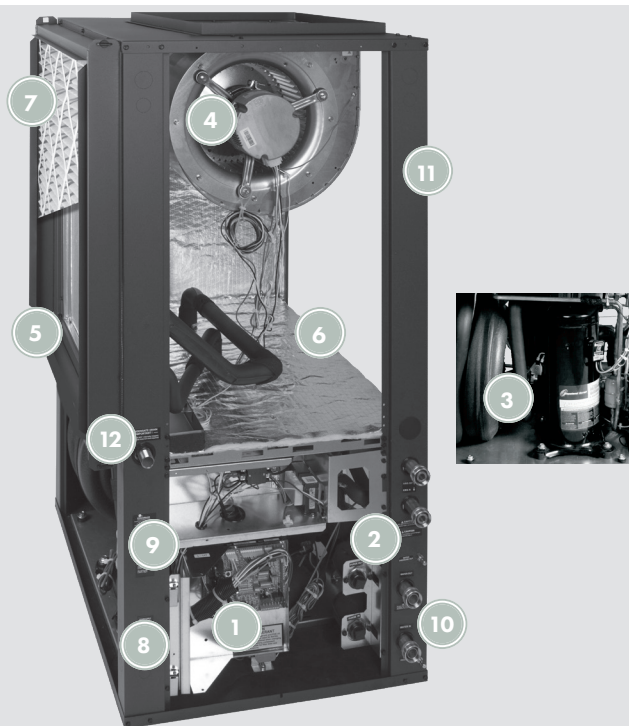

- 11 Heavy Gauge Galvanized Steel Cabinet is epoxy powder-coated in a durable and attractive black matte finish with stainless steel front access panels
- 12 Designed for External P-trap to eliminate internal drain-line cleanouts

# Unit Model Key

**1 2** **TE** **3** **V** **4 5 6** **026** **7** **B** **8** **G** **9** **D** **10** **0** **11** **2** **12** **C** **13** **L** **14** **T** **15** **S**

**SERIES**  
TE = Tranquility® 30 Digital

**CONFIGURATION**  
V = Vertical Up  
H = Horizontal  
D = Down Flow

**UNIT SIZE**  
026  
038  
049  
064  
072

**REVISION LEVEL**  
B = Current Revision

**VOLTAGE**  
G = 208/230/60/1 $\phi$

**CONTROLS**  
D = DXM2.5  
B = DXM2.5 w/Disconnect  
4 = DXM2.5 w/SecureStart

**CABINET**  
0 = Residential w/ 2" Merv 11 pleated filter and frame

**STANDARD**  
S = Standard

**SUPPLY AIR FLOW & MOTOR CONFIGURATION**

	Supply	Configuration
T	Top	TEV
B	Back	TEH
S	Straight	TEH
D	Down	TED

**RETURN AIR FLOW CONFIGURATION**  
L = Left Return  
R = Right Return

**HEAT EXCHANGER OPTIONS**

	Copper	Cupro-Nickel
HWG W/Pump (Standard)	C	N
No HWG	A	J
ClimaDry Reheat	D	F
ClimaDry and HWG W/Pump	L	M

**WATER CIRCUIT OPTIONS**  
0 = None  
1 = Internal Flow Controller Standard Head w/ check valve – Closed Loop (available for unit sizes 026 to 038 only)  
A = Internal Flow Controller Standard Head w/o check valve – Closed Loop (available for unit sizes 026 to 038 only)  
2 = Internal Flow Controller High Head w/ check valve – Closed Loop  
B = Internal Flow Controller High Head w/o check valve – Closed Loop  
5 = Motorized Modulating Valve (Central Pumping Applications) – Closed Loop  
6 = Motorized Modulating Valve (Ground Water Applications) – Open Loop

All Open Loop vFlow Water Circuit Options require a Cupro-Nickel Coil Heat Exchanger.  
All Closed Loop vFlow Water Circuit Options require a Copper Coil Heat Exchanger.  
If "None" is selected then the Heat Exchanger can be either Copper or Cupro-Nickel.  
If ClimaDry is selected in Digit 12, Digit 11 must be "0" for No Water Circuit Options.



## AHRI/ISO/ASHRAE 13256-1

ASHRAE/AHRI/ISO 13256-1

Model	Capacity Modulation	Water Loop Heat Pump				Ground Water Heat Pump				Ground Loop Heat Pump			
		Cooling 86°F		Heating 68°F		Cooling 59°F		Heating 50°F		Cooling Full Load 77°F Part Load 68°F		Heating Full Load 32°F Part Load 41°F	
		Capacity Btuh	EER Btuh/W	Capacity Btuh	COP	Capacity Btuh	EER Btuh/W	Capacity Btuh	COP	Capacity Btuh	EER Btuh/W	Capacity Btuh	COP
TE026	Part	19,200	19.8	23,600	7.0	22,000	34.1	19,000	5.4	20,800	28.0	16,800	5.0
	Full	25,000	17.4	31,400	6.0	28,500	26.4	25,800	5.1	26,000	19.9	20,200	4.1
TE038	Part	27,400	20.1	32,600	6.5	30,700	34.4	27,300	5.5	29,700	29.6	23,800	4.8
	Full	37,700	17.9	45,700	5.8	42,100	26.1	37,900	5.2	39,000	20.3	29,700	4.4
TE049	Part	36,300	18.8	42,200	6.1	41,800	32.9	34,800	5.0	39,100	27.4	29,800	4.4
	Full	48,600	16.8	56,700	5.1	55,000	25.3	46,800	4.6	49,600	19.3	36,400	4.0
TE064	Part	46,300	18.7	54,700	6.0	53,100	32.4	44,000	5.0	51,200	26.7	38,100	4.4
	Full	61,500	16.2	77,400	5.4	71,500	24.4	63,200	4.8	66,200	18.8	48,700	3.9
TE072	Part	53,000	16.8	64,600	5.2	60,800	28.6	53,200	4.5	58,100	23.2	46,000	3.9
	Full	68,300	15.1	85,300	4.8	77,700	22.5	71,400	4.4	71,700	16.9	55,800	3.7

### About AHRI/ISO/ASHRAE 13256-1

AHRI/ASHRAE/ISO 13256-1 (Air-Conditioning and Refrigeration Institute/American Society of Heating, Refrigerating and Air Conditioning Engineers/International Standards Organization) is a certification standard for water-source heat pumps used in the following applications:

- WLHP (Water Loop Heat Pump – Boiler/Tower)
- GWHP (Ground Water Heat Pump – Open Loop)
- GLHP (Ground Loop Heat Pump – Geothermal)

The directory at <http://www.ahrinet.org/> is constantly being updated and immediately available on the Internet.

Water and air temperatures used in AHRI certification standards are shown below.

### Test Condition Comparison Table

	WLHP	GWHP	GLHP
<b>Cooling</b>			
Entering Air Temperature - DB/WB °F [°C]	80.6/66.2 [27/19]	80.6/66.2 [27/19]	80.6/66.2 [27/19]
Entering Water Temperature - °F [°C]	86 [30]	59 [15]	77 [25]
Fluid Flow Rate	*	*	*
<b>Heating</b>			
Entering Air Temperature - DB/WB °F [°C]	68 [20]	68 [20]	68 [20]
Entering Water Temperature - °F [°C]	68 [20]	50 [10]	32 [0]
Fluid Flow Rate	*	*	*

\*Flow rate is specified by the manufacturer

Data certified by AHRI include heating/cooling capacities, EER (Energy Efficiency Ratio – Btuh per Watt) and COP (Btuh per Btuh) at the various conditions shown above. Pump power correction is calculated to adjust efficiencies for pumping Watts. Fan power is corrected to zero external static pressure using the equation below. The nominal airflow is rated at a specific external static pressure.

- Fan Power Correction = (cfm × 0.472) × (esp × 249)/300

Capacities and efficiencies are calculated using the following equations:

- ISO Cooling Capacity = Cooling Capacity (Btuh) + [Fan Power Correction (Watts) × 3.412]
- ISO EER Efficiency (Btuh/W) =  
ISO Cooling Capacity (Btuh)/[Power Input (Watts) – Fan Power Correction (Watts) + Pump Power Correction (Watts)]
- ISO Heating Capacity = Heating Capacity (Btuh) – [Fan Power Correction (Watts) × 3.412]
- ISO COP Efficiency (Btuh/Btuh) =  
ISO Heating Capacity (Btuh) × 3.412/[Power Input (Watts) - Fan Power Correction (Watts) + Pump Power Correction (Watts)]

## Reference Calculations & Legend

Heating		Cooling	
$LWT = EWT - \frac{HE}{GPM \times 500}$	$LWT = EWT + \frac{HR}{GPM \times 500}$	$LC = TC - SC$	
$LAT = EAT + \frac{HC}{CFM \times 1.08}$	$LAT (DB) = EAT (DB) - \frac{SC}{CFM \times 1.08}$	$S/T = \frac{SC}{TC}$	

Hot Water Generator capacities (HWC) are based on potable water flow rate of 0.4 gpm per nominal equipment ton and 90°F entering potable water temperature.

CFM = airflow, cubic feet/minute	HE = total heat of extraction, Mbtuh
EWT = entering water temperature, °F	HWC = Hot Water Generator (desuperheater) capacity, Mbtuh
GPM = water flow in US gallons/minute	WPD = Water coil pressure drop (psi & ft hd)
EAT = entering air temperature, Fahrenheit (dry bulb/wet bulb)	EER = Energy Efficiency Ratio = BTU output/Watt input
HC = air heating capacity, Mbtuh	COP = Coefficient of Performance = BTU output/BTU input
TC = total cooling capacity, Mbtuh	LWT = leaving water temperature, °F
SC = sensible cooling capacity, Mbtuh	LAT = leaving air temperature, °F
KW = total power unit input, KiloWatts	LC = latent cooling capacity, Mbtuh
HR = total heat of rejection, Mbtuh	S/T = sensible to total cooling ratio

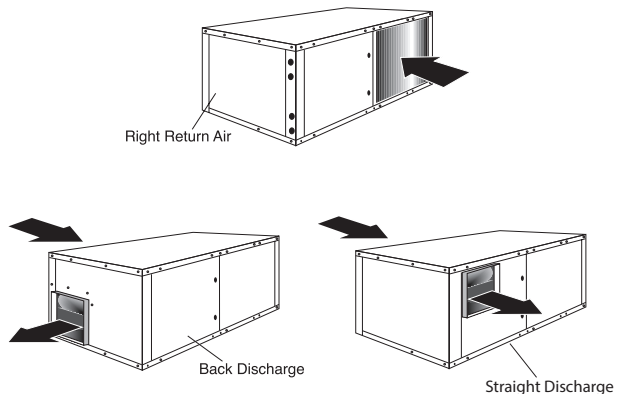
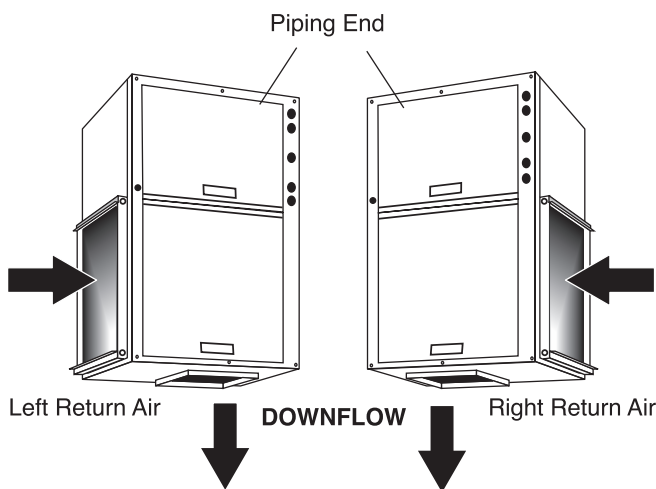
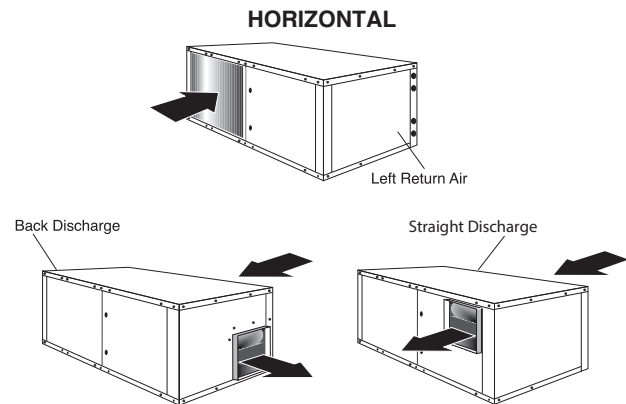
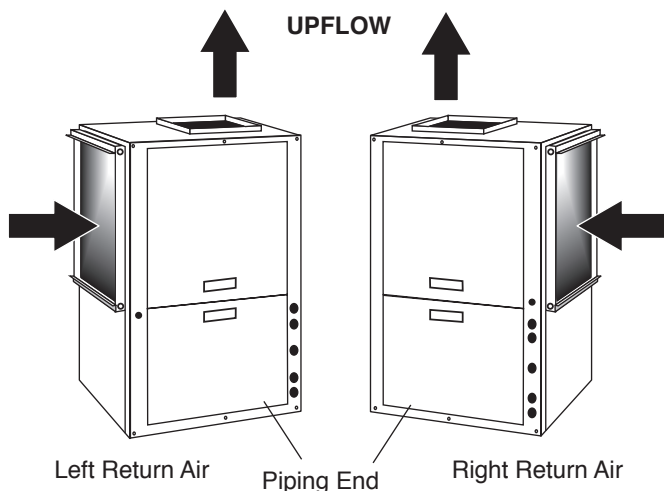

Full Load Correction Factors

**Air Flow Correction Table**

Airflow % of Rated	Cooling				Heating		
	Total Capacity	Sensible Capacity	Power	Heat of Rejection	Heating Capacity	Power	Heat of Extraction
60%	0.925	0.788	0.913	0.922	0.946	1.153	0.896
69%	0.946	0.829	0.926	0.942	0.959	1.107	0.924
75%	0.960	0.861	0.937	0.955	0.969	1.078	0.942
81%	0.972	0.895	0.950	0.968	0.977	1.053	0.959
88%	0.983	0.930	0.965	0.979	0.985	1.032	0.974
94%	0.992	0.965	0.982	0.990	0.993	1.014	0.988
100%	1.000	1.000	1.000	1.000	1.000	1.000	1.000
106%	1.007	1.033	1.020	1.009	1.006	0.989	1.011
113%	1.012	1.064	1.042	1.018	1.012	0.982	1.019
119%	1.016	1.092	1.066	1.025	1.018	0.979	1.027
125%	1.018	1.116	1.091	1.032	1.022	0.977	1.033
130%	1.019	1.132	1.112	1.037	1.026	0.975	1.038

**Entering Air Correction Table**

Heating			
Entering Air DB°F	Heating Capacity	Power	Heat of Extraction
40	1.052	0.779	1.120
45	1.043	0.808	1.102
50	1.035	0.841	1.084
55	1.027	0.877	1.065
60	1.019	0.915	1.045
65	1.010	0.957	1.023
68	1.004	0.982	1.010
70	1.000	1.000	1.000
75	0.989	1.045	0.974
80	0.976	1.093	0.946

\* = Sensible capacity equals total capacity  
 AHRI/ISO/ASHRAE 13256-1 uses entering air conditions of Cooling - 80.6°F DB/66.2°F WB,  
 and Heating - 68°F DB/59°F WB entering air temperature

Cooling													
Entering Air WB°F	Total Capacity	Sensible Cooling Capacity Multiplier - Entering DB °F										Power	Heat of Rejection
		60	65	70	75	80	80.6	85	90	95	100		
45	0.832	*	*	*	*	*	*	*	*	*	*	0.946	0.853
50	0.850	1.004	1.174	*	*	*	*	*	*	*	*	0.953	0.870
55	0.880	0.694	0.902	1.115	*	*	*	*	*	*	*	0.964	0.896
60	0.922		0.646	0.875	1.103	1.329	*	*	*	*	*	0.977	0.932
65	0.975			0.639	0.869	1.096	1.123	1.320	*	*	*	0.993	0.979
66.2	0.990			0.582	0.812	1.039	1.066	1.262	*	*	*	0.997	0.991
67	1.000			0.545	0.774	1.000	1.027	1.223	1.444	*	*	1.000	1.000
70	1.040				0.630	0.853	0.880	1.075	1.297	*	*	1.011	1.035
75	1.117					0.601	0.627	0.821	1.046	1.275	1.510	1.033	1.101

## Part Load Correction Factors

### Air Flow Correction Table

Airflow % of Rated	Cooling				Heating		
	Total Capacity	Sensible Capacity	Power	Heat of Rejection	Heating Capacity	Power	Heat of Extraction
60%	0.920	0.781	0.959	0.927	0.946	1.241	0.881
69%	0.942	0.832	0.964	0.946	0.960	1.163	0.915
75%	0.956	0.867	0.696	0.959	0.969	1.115	0.937
81%	0.969	0.901	0.975	0.970	0.978	1.076	0.956
88%	0.981	0.934	0.982	0.981	0.986	1.043	0.973
94%	0.991	0.967	0.990	0.991	0.993	1.018	0.988
100%	1.000	1.000	1.000	1.000	1.000	1.000	1.000
106%	1.007	1.033	1.011	1.008	1.006	0.990	1.010
113%	1.013	1.065	1.023	1.015	1.012	0.986	1.017
119%	1.018	1.098	1.036	1.021	1.017	0.983	1.024
125%	1.021	1.131	1.051	1.026	1.021	0.981	1.030
130%	1.023	1.159	1.063	1.030	1.024	0.979	1.034

### Entering Air Correction Table

Heating			
Entering Air DB°F	Heating Capacity	Power	Heat of Extraction
40	1.084	0.732	1.161
45	1.073	0.764	1.140
50	1.060	0.802	1.117
55	1.046	0.846	1.090
60	1.031	0.893	1.061
65	1.016	0.945	1.031
68	1.006	0.978	1.013
70	1.000	1.000	1.000
75	0.984	1.058	0.968
80	0.968	1.117	0.936

\* = Sensible capacity equals total capacity  
 AHRI/ISO/ASHRAE 13256-1 uses entering air conditions of Cooling - 80.6°F DB/66.2°F WB,  
 and Heating - 68°F DB/59°F WB entering air temperature

Cooling													
Entering Air WB°F	Total Capacity	Sensible Cooling Capacity Multiplier - Entering DB °F										Power	Heat of Rejection
		60	65	70	75	80	80.6	85	90	95	100		
45	0.876	*	*	*	*	*	*	*	*	*	*	0.981	0.895
50	0.883	1.002	1.099	*	*	*	*	*	*	*	*	0.985	0.901
55	0.903	0.706	0.871	1.060	*	*	*	*	*	*	*	0.989	0.918
60	0.935		0.617	0.844	1.079	*	*	*	*	*	*	0.993	0.945
65	0.979			0.595	0.849	1.098	1.128	*	*	*	*	0.998	0.982
66.2	0.991			0.531	0.789	1.040	1.070	1.284	*	*	*	0.999	0.993
67	1.000			0.486	0.747	1.000	1.030	1.245	*	*	*	1.000	1.000
70	1.035				0.583	0.842	0.873	1.090	1.327	*	*	1.003	1.030
75	1.105					0.552	0.584	0.811	1.057	1.290	*	1.008	1.088



Correction Tables - Antifreeze and Water Pressure Drop Adder for Options

**Antifreeze Correction Table**

Antifreeze Type	Antifreeze %	Cooling			Heating		WPD Corr. Fct. EWT 30°F
		EWT 90°F			EWT 30°F		
		Total Cap	Sens Cap	Power	Htg Cap	Power	
Water	0	1.000	1.000	1.000	1.000	1.000	1.000
Propylene Glycol	5	0.995	0.995	1.003	0.989	0.997	1.070
	15	0.986	0.986	1.009	0.968	0.990	1.210
	25	0.978	0.978	1.014	0.947	0.983	1.360
Methanol	5	0.997	0.997	1.002	0.989	0.997	1.070
	15	0.990	0.990	1.007	0.968	0.990	1.160
	25	0.982	0.982	1.012	0.949	0.984	1.220
Ethanol	5	0.998	0.998	1.002	0.981	0.994	1.140
	15	0.994	0.994	1.005	0.944	0.983	1.300
	25	0.986	0.986	1.009	0.917	0.974	1.360
Ethylene Glycol	5	0.998	0.998	1.002	0.993	0.998	1.040
	15	0.994	0.994	1.004	0.980	0.994	1.120
	25	0.988	0.988	1.008	0.966	0.990	1.200

**Modulating Valves for Closed Loop Applications, Low System Pressure Drop**

Model	CV	Close Off	MOPD	WPD Adders		
				GPM	PSI	FT
026	4.7	200	30	3	0.41	0.94
	4.7	200	30	4.5	0.92	2.12
	4.7	200	30	6	1.63	3.76
038	7.4	200	30	4.5	0.37	0.85
	7.4	200	30	6.8	0.84	1.95
	7.4	200	30	9	1.48	3.42
049	10	200	30	6	0.36	0.83
	10	200	30	9	0.81	1.87
	10	200	30	12	1.44	3.33
064	19	200	30	7.5	0.16	0.36
	19	200	30	11.3	0.35	0.82
	19	200	30	15	0.62	1.44
072	19	200	30	8.5	0.20	0.46
	19	200	30	12.8	0.45	1.05
	19	200	30	17	0.80	1.85

**Modulating Valves for Closed Loop Applications, High System Pressure Drop**

Model	CV	Close Off	MOPD	WPD Adders		
				GPM	PSI	FT
026	4.7	200	30	3	0.41	0.94
	4.7	200	30	4.5	0.92	2.12
	4.7	200	30	6	1.63	3.76
038	4.7	200	30	4.5	0.92	2.12
	4.7	200	30	6.8	2.09	4.84
	4.7	200	30	9	3.67	8.47
049	4.7	200	30	6	1.63	3.76
	4.7	200	30	9	3.67	8.47
	4.7	200	30	12	6.52	15.06
064	7.4	200	30	7.5	1.03	2.37
	7.4	200	30	11.3	2.33	5.39
	7.4	200	30	15	4.11	9.49
072	7.4	200	30	8.5	1.32	3.05
	7.4	200	30	12.8	2.99	6.91
	7.4	200	30	17	5.28	12.19

**ClimaDry® Additional Pressure Drop (When Operating in Non-ClimaDry® Mode)**

Model	WPD Adders (Part Load)			WPD Adders (Full Load)		
	GPM	PSI	FT	GPM	PSI	FT
026	3.5	1.200	2.771	4.0	1.567	3.620
	5.8	3.294	7.610	6.0	3.526	8.144
038	4.0	0.689	1.592	4.5	0.872	2.015
	6.0	1.551	3.583	6.8	1.992	4.602
049	5.5	1.303	3.011	6.0	1.551	3.583
	8.3	2.968	6.856	9.0	3.490	8.062
064	7.0	1.299	3.001	7.5	1.491	3.445
	10.5	2.923	6.752	11.3	3.385	7.820
072	7.5	1.491	3.445	8.5	1.915	4.425
	11.3	3.385	7.820	12.8	4.344	10.034

## Performance Data Selection Notes - vFlow® Models

### Operation in Shaded Area: Closed Loop Application

For operation in the shaded area, appropriate levels of a proper antifreeze should be used in systems with leaving water temperatures of 40°F or below and the JW3 jumper should be clipped. This is due to the potential of the refrigerant temperature being as low as 32°F [0°C] with 40°F [4.4°C] LWT, which may lead to a nuisance cutout due to the activation of the Low Temperature Protection. JW3 should never be clipped for systems without antifreeze.

### Open Loop Application:

For operation in shaded area (below 40°F LWT) in open loop applications, ΔT (on DXM2.5) should be set such that the LWT (=EWT - ΔT) doesn't drop below 40°F. JW3 should NEVER be clipped for systems without antifreeze.

Recommended in this range. Also Clip JW3 on DXM2.5 boards

**Heating - EAT 70°F**

TD	FT	CFM	HC	kW	COP	HE	LAT	LWT	HWC
5.5	5.8	725	11.3	1.1	2.9	7.4	84	16.7	1.2
5.5	5.8	850	11.5	1.1	3.1	7.7	82	16.6	1.2
5.7	1.7	725	12.5	1.1	3.2	8.6	86	22.4	1.4
5.7	1.7	850	12.7	1.1	3.4	8.9	84	22.1	1.3
5.3	3.0	725	13.1	1.1	3.3	9.1	87	24.6	1.4
5.3	3.0	850	13.2	1.1	3.5	9.5	84	24.4	1.4
5.0	4.6	725	13.4	1.1	3.4	9.4	87	25.8	1.4
5.0	4.6	850	13.5	1.1	3.6	9.8	85	25.7	1.4
4.2	1.2	725	14.5	1.2	3.7	10.6	89	30.6	1.6
4.2	1.2	850	14.7	1.1	3.9	10.9	86	30.3	1.5
3.4	2.4	725	15.2	1.2	3.9	11.3	89	33.4	1.6
3.4	2.4	850	15.4	1.1	4.1	11.7	87	33.1	1.6
2.8	2.8	725	15.6	1.2	4.0	11.7	90	34.8	1.6
2.8	2.8	850	15.8	1.1	4.2	12.1	87	34.6	1.6
2.2	2.2	725	16.6	1.2	4.2	12.6	91	38.8	1.8
2.2	2.2	850	16.8	1.1	4.4	13.0	88	38.6	1.8
1.6	1.6	725	17.5	1.2	4.4	13.5	92	41.8	1.8
1.6	1.6	850	17.7	1.1	4.7	14.1	89	41.6	1.8

### Performance Data Selection Notes - Models without vFlow®

For operation in the shaded area when water is used in lieu of an antifreeze solution, the LWT (Leaving Water Temperature) must be calculated. Flow must be maintained to a level such that the LWT is maintained above 40°F [4.4°C] when the JW3 jumper is not clipped (see example below). Otherwise, appropriate levels of a proper antifreeze solution should be used in systems with leaving water temperatures of 40°F [4.4°C] or below and the JW3 jumper should be clipped. This is due to the potential of the refrigerant temperature being as low as 32°F [0°C] with 40°F [4.4°C] LWT, which may lead to a nuisance cutout due to the activation of the Low Temperature Protection. JW3 should never be clipped for standard range equipment or systems without antifreeze.

Example:

At 50°F EWT (Entering Water Temperature) and 1.5 gpm/ton, a 3 ton unit has a HE of 22,500 Btuh. To calculate LWT, rearrange the formula for HE as follows:

HE = TD × GPM × 500, where HE = Heat of Extraction (Btuh); TD = temperature difference (EWT - LWT) and GPM = U.S. Gallons per Minute.

$$TD = HE / (GPM \times 500)$$

$$TD = 22,500 / (4.5 \times 500)$$

$$TD = 10^\circ\text{F}$$

$$\text{LWT} = \text{EWT} - \text{TD}$$

$$\text{LWT} = 50 - 10 = 40^\circ\text{F}$$

In this example, as long as the EWT does not fall below 50°F, the system will operate as designed. For EWTs below 50°F, higher flow rates will be required (open loop systems, for example, require at least 2 gpm/ton when EWT is below 50°F).

**Heating - EAT 70°F**

TD	Airflow CFM	HC	kW	HE	LAT	COP
5.5	710	11.6	1.05	8.2	85.1	3.25
5.5	825	11.7	1.02	8.4	83.2	3.38
5.3	710	13.6	1.09	10.1	87.8	3.66
5.3	825	13.8	1.06	10.3	85.5	3.81
4.7	710	14.2	1.09	10.7	88.5	3.81
4.7	825	14.4	1.06	10.9	86.1	3.97
4.2	710	14.4	1.09	10.9	88.8	3.86
4.2	825	14.6	1.06	11.1	86.3	4.02
3.4	710	16.1	1.15	12.3	90.9	4.08
3.4	825	16.2	1.12	12.6	88.2	4.25
2.8	710	16.7	1.15	13.0	91.8	4.25
2.8	825	16.9	1.12	13.3	89.0	4.42
2.2	710	16.9	1.16	13.2	92.1	4.30
2.2	825	17.1	1.12	13.5	89.2	4.47
1.6	710	18.3	1.18	14.5	93.9	4.56
1.6	825	18.5	1.14	14.8	90.8	4.75
1.2	710	19.1	1.18	15.2	94.8	4.73
1.2	825	19.3	1.15	15.5	91.6	4.93
0.8	710	19.3	1.18	15.4	95.1	4.78
0.8	825	19.5	1.15	15.7	91.9	4.98
0.4	710	20.4	1.21	16.5	96.6	4.92
0.4	825	20.6	1.18	16.8	93.2	5.12
0.2	710	21.2	1.22	17.3	97.7	5.02
0.2	825	21.4	1.18	17.6	94.4	5.22

Performance Data — Tranquility® 30 Model 026 - Part Load, with vFlow®

Performance capacities shown in thousands of Btuh

Antifreeze use recommended in this range.  
Also Clip JW3 on DXM2.5 board.

EWT °F	Cooling - EAT 80/67 °F										Heating - EAT 70°F											
	GPM	WPD		CFM	TC	SC	kW	EER	HR	LWT	HWC	GPM	WPD		CFM	HC	kW	COP	HE	LAT	LWT	HWC
		PSI	FT										PSI	FT								
20	1.0	0.2	0.3	660	22.6	14.9	0.74	30.7	25.1	70.0	1.0	4.5	1.2	2.9	750	11.5	1.25	2.7	7.4	84.2	16.7	1.2
	1.0	0.2	0.4	750	23.0	16.0	0.75	30.7	25.6	70.0	1.0	4.5	1.2	2.9	850	11.7	1.20	2.9	7.6	82.7	16.6	1.2
30	1.3	0.2	0.4	660	22.6	14.9	0.74	30.7	25.1	70.0	1.0	2.3	0.5	1.1	750	13.0	1.23	3.1	8.9	86.0	22.2	1.3
	1.3	0.2	0.4	750	23.0	16.0	0.75	30.7	25.6	70.0	1.0	2.3	0.5	1.1	850	13.2	1.18	3.3	9.2	84.4	22.0	1.3
	1.3	0.2	0.4	660	22.6	14.9	0.74	30.7	25.1	70.0	1.0	3.4	0.8	1.8	750	13.6	1.22	3.3	9.5	86.8	24.4	1.3
	1.3	0.2	0.4	750	23.0	16.0	0.75	30.7	25.6	70.0	1.0	3.4	0.8	1.8	850	13.8	1.17	3.5	9.8	85.0	24.2	1.4
	1.3	0.2	0.4	660	22.6	14.9	0.74	30.7	25.1	70.0	1.0	4.5	1.1	2.6	750	13.9	1.21	3.4	9.9	87.2	25.6	1.4
	1.3	0.2	0.4	750	23.0	16.0	0.75	30.7	25.6	70.0	1.0	4.5	1.1	2.6	850	14.1	1.16	3.6	10.2	85.4	25.5	1.4
40	1.7	0.3	0.6	660	22.6	14.9	0.74	30.7	25.1	70.0	1.0	2.3	0.4	1.0	750	15.2	1.20	3.7	11.2	88.8	30.3	1.5
	1.7	0.3	0.6	750	23.0	16.0	0.75	30.7	25.6	70.0	1.0	2.3	0.4	1.0	850	15.4	1.15	3.9	11.5	86.8	30.0	1.5
	1.7	0.3	0.6	660	22.6	14.9	0.74	30.7	25.1	70.0	1.0	3.4	0.7	1.7	750	16.0	1.19	3.9	12.0	89.7	33.0	1.5
	1.7	0.3	0.6	750	23.0	16.0	0.75	30.7	25.6	70.0	1.0	3.4	0.7	1.7	850	16.2	1.14	4.2	12.3	87.6	32.8	1.6
	1.7	0.3	0.6	660	22.6	14.9	0.74	30.7	25.1	70.0	1.0	4.5	1.1	2.5	750	16.4	1.18	4.1	12.4	90.2	34.5	1.6
	1.7	0.3	0.6	750	23.0	16.0	0.75	30.7	25.6	70.0	1.0	4.5	1.1	2.5	850	16.6	1.13	4.3	12.8	88.1	34.3	1.6
50	2.3	0.4	1.0	660	22.4	14.9	0.76	29.7	25.0	71.7	1.1	2.3	0.4	1.0	750	17.4	1.17	4.4	13.4	91.5	38.3	1.7
	2.3	0.4	1.0	750	22.9	15.9	0.77	29.7	25.5	72.2	1.1	2.3	0.4	1.0	850	17.7	1.12	4.6	13.8	89.2	38.0	1.7
	2.5	0.5	1.1	660	22.6	14.9	0.74	30.7	25.1	70.0	1.0	3.4	0.7	1.6	750	18.3	1.16	4.6	14.4	92.6	41.5	1.7
	2.5	0.5	1.1	750	23.0	16.0	0.75	30.7	25.6	70.0	1.0	3.4	0.7	1.6	850	18.6	1.11	4.9	14.8	90.3	41.3	1.8
	2.5	0.5	1.1	660	22.6	14.9	0.74	30.7	25.1	70.0	1.0	4.5	1.0	2.3	750	18.9	1.16	4.8	14.9	93.3	43.4	1.8
	2.5	0.5	1.1	750	23.0	16.0	0.75	30.7	25.6	70.0	1.0	4.5	1.0	2.3	850	19.1	1.11	5.1	15.4	90.8	43.2	1.8
60	2.3	0.4	1.0	660	21.5	14.5	0.86	24.8	24.4	81.2	1.4	2.3	0.4	1.0	750	19.6	1.15	5.0	15.7	94.3	46.3	1.8
	2.3	0.4	1.0	750	21.9	15.5	0.88	24.9	24.9	81.6	1.5	2.3	0.4	1.0	850	19.9	1.10	5.3	16.2	91.7	45.9	1.9
	3.4	0.7	1.6	660	22.2	14.8	0.79	28.2	24.9	74.6	1.2	3.4	0.7	1.6	750	20.8	1.14	5.3	16.9	95.6	50.1	1.9
	3.4	0.7	1.6	750	22.6	15.8	0.80	28.3	25.3	74.9	1.2	3.4	0.7	1.6	850	21.1	1.09	5.7	17.3	92.9	49.8	1.9
	4.5	1.0	2.3	660	22.5	14.9	0.75	30.1	25.0	71.1	1.0	4.5	1.0	2.3	750	21.4	1.14	5.5	17.5	96.4	52.2	2.0
	4.5	1.0	2.3	750	22.9	15.9	0.76	30.2	25.5	71.3	1.1	4.5	1.0	2.3	850	21.7	1.09	5.8	18.0	93.6	52.0	2.0
70	2.3	0.4	1.0	660	20.3	14.0	0.98	20.6	23.6	90.5	2.0	2.3	0.4	1.0	750	21.9	1.14	5.7	18.0	97.1	54.3	2.0
	2.3	0.4	1.0	750	20.7	15.0	1.00	20.7	24.1	90.9	2.0	2.3	0.4	1.0	850	22.3	1.09	6.0	18.5	94.2	53.9	2.0
	3.4	0.7	1.6	660	21.1	14.4	0.89	23.6	24.2	84.2	1.6	3.4	0.7	1.6	750	23.2	1.14	6.0	19.3	98.7	58.6	2.1
	3.4	0.7	1.6	750	21.5	15.4	0.91	23.7	24.6	84.5	1.6	3.4	0.7	1.6	850	23.6	1.09	6.3	19.9	95.7	58.3	2.1
	4.5	1.0	2.2	660	21.5	14.5	0.85	25.2	24.4	80.9	1.4	4.5	1.0	2.2	750	24.0	1.14	6.2	20.1	99.6	61.1	2.1
	4.5	1.0	2.2	750	21.9	15.6	0.87	25.2	24.9	81.1	1.4	4.5	1.0	2.2	850	24.3	1.09	6.5	20.6	96.5	60.8	2.2
80	2.3	0.4	1.0	660	18.9	13.4	1.12	16.9	22.7	99.8	2.6	2.3	0.4	1.0	750	24.3	1.14	6.3	20.4	100.0	62.3	2.1
	2.3	0.4	1.0	750	19.3	14.3	1.14	16.9	23.2	100.1	2.6	2.3	0.4	1.0	850	24.6	1.09	6.6	20.9	96.8	61.8	2.2
	3.4	0.7	1.5	660	19.8	13.8	1.02	19.4	23.3	93.7	2.2	2.8	0.5	1.2	750	25.2	1.14	6.5	21.3	101.1	65.0	2.2
	3.4	0.7	1.5	750	20.2	14.8	1.04	19.4	23.8	94.0	2.2	2.9	0.6	1.3	850	25.6	1.09	6.9	21.9	97.9	65.0	2.2
	4.5	0.9	2.2	660	20.3	14.0	0.98	20.7	23.6	90.5	1.9	2.8	0.5	1.2	750	25.2	1.14	6.5	21.3	101.1	65.0	2.2
	4.5	0.9	2.2	750	20.7	15.0	1.00	20.7	24.1	90.7	2.0	2.9	0.6	1.3	850	25.6	1.09	6.9	21.9	97.9	65.0	2.2
90	2.3	0.4	1.0	660	17.5	12.7	1.28	13.7	21.8	109.0	3.4	1.7	0.3	0.6	750	25.2	1.14	6.5	21.3	101.1	65.0	2.2
	2.3	0.4	1.0	750	17.8	13.6	1.30	13.7	22.2	109.3	3.4	1.7	0.3	0.7	850	25.6	1.09	6.9	21.9	97.9	65.0	2.2
	3.4	0.7	1.5	660	18.4	13.1	1.17	15.7	22.4	103.2	2.9	1.7	0.3	0.6	750	25.2	1.14	6.5	21.3	101.1	65.0	2.2
	3.4	0.7	1.5	750	18.7	14.1	1.19	15.8	22.8	103.4	2.9	1.7	0.3	0.7	850	25.6	1.09	6.9	21.9	97.9	65.0	2.2
	4.5	0.9	2.2	660	18.9	13.4	1.12	16.9	22.7	100.1	2.6	1.7	0.3	0.6	750	25.2	1.14	6.5	21.3	101.1	65.0	2.2
	4.5	0.9	2.2	750	19.2	14.3	1.14	16.9	23.1	100.3	2.7	1.7	0.3	0.7	850	25.6	1.09	6.9	21.9	97.9	65.0	2.2
100	2.3	0.4	1.0	660	16.0	12.1	1.45	11.0	21.0	118.2	4.3	1.2	0.1	0.3	750	25.2	1.14	6.5	21.3	101.1	65.0	2.2
	2.3	0.4	1.0	750	16.3	13.0	1.48	11.0	21.4	118.6	4.3	1.2	0.1	0.3	850	25.6	1.09	6.9	21.9	97.9	65.0	2.2
	3.4	0.7	1.5	660	16.9	12.5	1.34	12.7	21.5	112.6	3.7	1.2	0.1	0.3	750	25.2	1.14	6.5	21.3	101.1	65.0	2.2
	3.4	0.7	1.5	750	17.2	13.4	1.36	12.7	21.9	112.9	3.8	1.2	0.1	0.3	850	25.6	1.09	6.9	21.9	97.9	65.0	2.2
	4.5	0.9	2.1	660	17.4	12.7	1.29	13.5	21.8	109.7	3.4	1.2	0.1	0.3	750	25.2	1.14	6.5	21.3	101.1	65.0	2.2
	4.5	0.9	2.1	750	17.7	13.6	1.31	13.5	22.2	109.9	3.5	1.2	0.1	0.3	850	25.6	1.09	6.9	21.9	97.9	65.0	2.2
110	2.3	0.4	0.9	660	14.6	11.6	1.65	8.9	20.3	127.6	5.3	0.9	0.1	0.2	750	25.2	1.14	6.5	21.3	101.1	65.0	2.2
	2.3	0.4	0.9	750	14.9	12.4	1.68	8.9	20.6	128.0	5.4	1.0	0.1	0.2	850	25.6	1.09	6.9	21.9	97.9	65.0	2.2
	3.4	0.7	1.5	660	15.4	11.9	1.53	10.1	20.6	122.1	4.7	0.9	0.1	0.2	750	25.2	1.14	6.5	21.3	101.1	65.0	2.2
	3.4	0.7	1.5	750	15.7	12.7	1.56	10.1	21.0	122.4	4.8	1.0	0.1	0.2	850	25.6	1.09	6.9	21.9	97.9	65.0	2.2
	4.5	0.9	2.1	660	15.9	12.1	1.46	10.9	20.9	119.3	4.3	0.9	0.1	0.2	750	25.2	1.14	6.5	21.3	101.1	65.0	2.2
	4.5	0.9	2.1	750	16.2	12.9	1.49	10.9	21.3	119.5	4.4	1.0	0.1	0.2	850	25.6	1.09	6.9	21.9	97.9	65.0	2.2
120	2.3	0.4	0.9	660	13.4	11.3	1.88	7.2	19.8	137.2	6.5	0.8	0.1	0.2	750	25.2	1.14	6.5	21.3	101.1	65.0	2.2
	2.3	0.4	0.9	750	13.7	12.1	1.91	7.2	20.2	137.6	6.6	0.8	0.1	0.2	850	25.6	1.09	6.9	21.9	97.9	65.0	2.2
	3.4	0.6	1.4	660	14.1	11.5	1.74	8.1	20.0	131.8	5.8	0.8	0.1	0.2	750	25.2	1.14	6.5	21.3	101.1	65.0	2.2
	3.4	0.6	1.4	750	14.4	12.3	1.77	8.1	20.4	132.0	5.9	0.8	0.1	0.2	850	25.6	1.09	6.9	21.9	97.9	65.0	2.2
	4.5	0.9	2.0	660	14.5	11.6	1.68	8.6	20.2	129.0	5.4	0.8	0.1	0.2	750	25.2	1.14	6.5				

Performance Data — Tranquility® 30 Model 026 - Full Load, with vFlow®

Performance capacities shown in thousands of Btuh

Antifreeze use recommended in this range.  
Also Clip JW3 on DXM2.5 board.

EWT °F	Cooling - EAT 80/67 °F										Heating - EAT 70°F											
	GPM	WPD		CFM	TC	SC	kW	EER	HR	LWT	HWC	GPM	WPD		CFM	HC	kW	COP	HE	LAT	LWT	HWC
		PSI	FT										PSI	FT								
20	1.3	0.3	0.6	750	29.3	18.1	1.16	25.3	33.2	70.0	1.4	6.0	1.9	4.4	840	16.5	1.73	2.8	10.7	88.2	16.4	1.5
	1.4	0.3	0.6	850	29.8	19.5	1.20	24.9	33.9	70.0	1.4	6.0	1.9	4.4	950	16.8	1.68	2.9	11.0	86.3	16.3	1.5
30	1.7	0.3	0.7	750	29.3	18.1	1.16	25.3	33.2	70.0	1.4	3.0	0.7	1.6	840	18.2	1.69	3.2	12.6	90.1	21.6	1.7
	1.7	0.3	0.7	850	29.8	19.5	1.20	24.9	33.9	70.0	1.4	3.0	0.7	1.6	950	18.5	1.64	3.3	12.9	88.0	21.4	1.8
	1.7	0.3	0.7	750	29.3	18.1	1.16	25.3	33.2	70.0	1.4	4.5	1.1	2.6	840	19.1	1.68	3.3	13.4	91.0	24.0	1.8
	1.7	0.3	0.7	850	29.8	19.5	1.20	24.9	33.9	70.0	1.4	4.5	1.1	2.6	950	19.4	1.63	3.5	13.8	88.9	23.9	1.9
	1.7	0.3	0.7	750	29.3	18.1	1.16	25.3	33.2	70.0	1.4	6.0	1.8	4.0	840	19.5	1.67	3.4	13.9	91.5	25.4	1.9
	1.7	0.3	0.7	850	29.8	19.5	1.20	24.9	33.9	70.0	1.4	6.0	1.8	4.0	950	19.8	1.62	3.6	14.3	89.3	25.2	1.9
40	2.2	0.4	1.0	750	29.3	18.1	1.16	25.3	33.2	70.0	1.4	3.0	0.6	1.5	840	21.0	1.66	3.7	15.4	93.1	29.7	2.1
	2.3	0.4	1.0	850	29.8	19.5	1.20	24.9	33.9	70.0	1.4	3.0	0.6	1.5	950	21.3	1.61	3.9	15.8	90.8	29.5	2.1
	2.2	0.4	1.0	750	29.3	18.1	1.16	25.3	33.2	70.0	1.4	4.5	1.1	2.5	840	22.0	1.65	3.9	16.5	94.3	32.7	2.2
	2.3	0.4	1.0	850	29.8	19.5	1.20	24.9	33.9	70.0	1.4	4.5	1.1	2.5	950	22.4	1.60	4.1	16.9	91.8	32.5	2.3
	2.2	0.4	1.0	750	29.3	18.1	1.16	25.3	33.2	70.0	1.4	6.0	1.6	3.8	840	22.6	1.64	4.0	17.1	94.9	34.3	2.3
	2.3	0.4	1.0	850	29.8	19.5	1.20	24.9	33.9	70.0	1.4	6.0	1.6	3.8	950	23.0	1.59	4.2	17.5	92.4	34.2	2.3
50	3.0	0.6	1.4	750	29.1	18.0	1.19	24.5	33.1	72.0	1.4	3.0	0.6	1.4	840	23.8	1.64	4.2	18.2	96.2	37.8	2.4
	3.0	0.6	1.4	850	29.6	19.4	1.23	24.0	33.8	72.5	1.5	3.0	0.6	1.4	950	24.1	1.59	4.5	18.7	93.5	37.5	2.5
	3.3	0.7	1.6	750	29.3	18.1	1.16	25.3	33.2	70.0	1.4	4.5	1.0	2.3	840	25.1	1.64	4.5	19.5	97.6	41.3	2.6
	3.4	0.7	1.6	850	29.8	19.5	1.20	24.9	33.9	70.0	1.4	4.5	1.0	2.3	950	25.4	1.59	4.7	20.0	94.8	41.1	2.6
	3.3	0.7	1.6	750	29.3	18.1	1.16	25.3	33.2	70.0	1.4	6.0	1.6	3.6	840	25.8	1.64	4.6	20.2	98.4	43.3	2.7
	3.4	0.7	1.6	850	29.8	19.5	1.20	24.9	33.9	70.0	1.4	6.0	1.6	3.6	950	26.2	1.59	4.8	20.7	95.5	43.1	2.7
60	3.0	0.6	1.3	750	27.9	17.6	1.30	21.4	32.3	81.5	1.9	3.0	0.6	1.3	840	26.7	1.64	4.8	21.1	99.4	45.9	2.8
	3.0	0.6	1.3	850	28.4	18.9	1.35	21.0	33.0	82.0	1.9	3.0	0.6	1.3	950	27.1	1.59	5.0	21.6	96.4	45.6	2.8
	4.5	1.0	2.3	750	28.8	17.9	1.22	23.7	32.9	74.6	1.5	4.5	1.0	2.3	840	28.2	1.65	5.0	22.5	101.0	50.0	2.9
	4.5	1.0	2.3	850	29.3	19.3	1.26	23.3	33.6	74.9	1.6	4.5	1.0	2.3	950	28.6	1.60	5.2	23.1	97.9	49.7	3.0
	6.0	1.5	3.5	750	29.2	18.1	1.18	24.8	33.1	71.0	1.4	6.0	1.5	3.5	840	29.0	1.66	5.1	23.3	102.0	52.2	3.0
	6.0	1.5	3.5	850	29.7	19.4	1.22	24.3	33.8	71.3	1.4	6.0	1.5	3.5	950	29.4	1.61	5.4	24.0	98.7	52.0	3.1
70	3.0	0.6	1.3	750	26.4	17.0	1.43	18.5	31.3	90.9	2.4	3.0	0.6	1.3	840	29.6	1.66	5.2	23.9	102.6	54.1	3.1
	3.0	0.6	1.3	850	26.9	18.3	1.48	18.2	32.0	91.3	2.4	3.0	0.6	1.3	950	30.1	1.61	5.5	24.6	99.3	53.6	3.2
	4.5	1.0	2.2	750	27.5	17.5	1.33	20.7	32.0	84.2	2.0	4.5	1.0	2.2	840	31.4	1.69	5.4	25.6	104.6	58.6	3.3
	4.5	1.0	2.2	850	28.0	18.8	1.38	20.3	32.7	84.5	2.1	4.5	1.0	2.2	950	31.8	1.64	5.7	26.2	101.0	58.3	3.3
	6.0	1.5	3.4	750	28.0	17.7	1.28	21.8	32.4	80.8	1.8	6.0	1.5	3.4	840	32.3	1.71	5.5	26.5	105.7	61.2	3.4
	6.0	1.5	3.4	850	28.5	19.0	1.33	21.4	33.1	81.0	1.9	6.0	1.5	3.4	950	32.8	1.66	5.8	27.2	102.0	60.9	3.4
80	3.0	0.6	1.3	750	24.8	16.3	1.58	15.7	30.2	100.1	3.0	3.0	0.6	1.3	840	32.6	1.71	5.6	26.7	106.0	62.2	3.4
	3.0	0.6	1.3	850	25.2	17.5	1.64	15.4	30.8	100.5	3.0	3.0	0.6	1.3	950	33.1	1.66	5.8	27.5	102.3	61.7	3.5
	4.5	0.9	2.2	750	26.0	16.8	1.48	17.6	31.0	93.8	2.6	3.7	0.7	1.7	840	33.9	1.74	5.7	27.9	107.4	65.0	3.5
	4.5	0.9	2.2	850	26.4	18.1	1.53	17.3	31.6	94.1	2.6	3.8	0.8	1.8	950	34.4	1.69	6.0	28.7	103.6	65.0	3.6
	6.0	1.4	3.3	750	26.2	16.9	1.45	18.1	31.1	90.4	2.4	3.7	0.7	1.7	840	33.9	1.74	5.7	27.9	107.4	65.0	3.5
	6.0	1.4	3.3	850	26.7	18.2	1.50	17.8	31.8	92.7	2.4	3.8	0.8	1.8	950	34.4	1.69	6.0	28.7	103.6	65.0	3.6
90	3.0	0.6	1.3	750	23.1	15.5	1.75	13.2	29.0	109.4	3.7	2.2	0.4	0.9	840	33.9	1.74	5.7	27.9	107.4	65.0	3.5
	3.0	0.6	1.3	850	23.5	16.7	1.81	13.0	29.7	109.8	3.7	2.3	0.4	1.0	950	34.4	1.69	6.0	28.7	103.6	65.0	3.6
	4.5	0.9	2.2	750	24.3	16.1	1.63	14.9	29.8	103.2	3.2	2.2	0.4	0.9	840	33.9	1.74	5.7	27.9	107.4	65.0	3.5
	4.5	0.9	2.2	850	24.7	17.3	1.69	14.6	30.4	103.5	3.3	2.3	0.4	1.0	950	34.4	1.69	6.0	28.7	103.6	65.0	3.6
	6.0	1.4	3.2	750	24.9	16.3	1.57	15.8	30.2	100.1	3.0	2.2	0.4	0.9	840	33.9	1.74	5.7	27.9	107.4	65.0	3.5
	6.0	1.4	3.2	850	25.3	17.5	1.63	15.5	30.9	100.3	3.0	2.3	0.4	1.0	950	34.4	1.69	6.0	28.7	103.6	65.0	3.6
100	3.0	0.6	1.3	750	21.3	14.8	1.95	10.9	28.0	118.7	4.4	1.6	0.2	0.6	840	33.9	1.74	5.7	27.9	107.4	65.0	3.5
	3.0	0.6	1.3	850	21.7	15.9	2.02	10.7	28.6	119.1	4.5	1.6	0.3	0.6	950	34.4	1.69	6.0	28.7	103.6	65.0	3.6
	4.5	0.9	2.1	750	22.5	15.3	1.81	12.4	28.7	112.7	3.9	1.6	0.2	0.6	840	33.9	1.74	5.7	27.9	107.4	65.0	3.5
	4.5	0.9	2.1	850	22.9	16.4	1.88	12.2	29.3	113.0	4.0	1.6	0.3	0.6	950	34.4	1.69	6.0	28.7	103.6	65.0	3.6
	6.0	1.4	3.2	750	23.1	15.5	1.76	13.1	29.0	109.7	3.7	1.6	0.2	0.6	840	33.9	1.74	5.7	27.9	107.4	65.0	3.5
	6.0	1.4	3.2	850	23.5	16.7	1.82	12.9	29.7	109.9	3.7	1.6	0.3	0.6	950	34.4	1.69	6.0	28.7	103.6	65.0	3.6
110	3.0	0.6	1.3	750	19.7	14.2	2.18	9.0	27.1	128.1	5.3	1.2	0.1	0.3	840	33.9	1.74	5.7	27.9	107.4	65.0	3.5
	3.0	0.6	1.3	850	20.0	15.2	2.26	8.9	27.7	128.5	5.4	1.3	0.1	0.3	950	34.4	1.69	6.0	28.7	103.6	65.0	3.6
	4.5	0.9	2.1	750	20.7	14.6	2.04	10.2	27.7	122.3	4.7	1.2	0.1	0.3	840	33.9	1.74	5.7	27.9	107.4	65.0	3.5
	4.5	0.9	2.1	850	21.1	15.7	2.11	10.0	28.2	122.6	4.8	1.3	0.1	0.3	950	34.4	1.69	6.0	28.7	103.6	65.0	3.6
	6.0	1.4	3.1	750	21.3	14.8	1.96	10.8	28.0	119.3	4.4	1.2	0.1	0.3	840	33.9	1.74	5.7	27.9	107.4	65.0	3.5
	6.0	1.4	3.1	850	21.6	15.9	2.03	10.6	28.6	119.5	4.5	1.3	0.1	0.3	950	34.4	1.69	6.0	28.7	103.6	65.0	3.6
120	3.0	0.5	1.2	750	18.2	13.7	2.46	7.4	26.6	137.7	6.2	1.0	0.1	0.2	840	33.9	1.74	5.7	27.9	107.4	65.0	3.5
	3.0	0.5	1.2	850	18.5	14.7	2.55	7.3	27.2	138.1	6.4	1.0	0.1	0.2	950	34.4	1.69	6.0	28.7	103.6	65.0	3.6
	4.5	0.9	2.0	750	19.1	14.0	2.29	8.3	26.9	132.0	5.6	1.0	0.1	0.2	840	33.9	1.74	5.7	27.9	107.4	65.0	3.5
	4.5	0.9	2.0	850	19.4	15.0	2.37	8.2	27.5	132.2	5.8	1.0	0.1	0.2	950	34.4	1.69	6.0	28.7	103.6	65.0	3.6
	6.0	1.3	3.1	750	19.5	14.1	2.20	8.9	27.1	129.0	5.3	1.0	0.1	0.2								



Performance Data — Tranquility® 30 Model 038 - Part Load, with vFlow®

Performance capacities shown in thousands of Btuh

EWT °F	Cooling - EAT 80/67 °F											Antifreeze use recommended in this range. Also Clip JW3 on DXM2.5 board. Heating - EAT 70°F										
	GPM	WPD		CFM	TC	SC	kW	EER	HR	LWT	HWC	GPM	WPD		CFM	HC	kW	COP	HE	LAT	LWT	HWC
		PSI	FT										PSI	FT								
20	1.5	0.4	1.0	880	32.8	20.8	1.01	32.5	36.3	70.0	1.2	6.0	2.5	5.7	880	16.9	1.65	3.0	11.5	87.8	16.2	1.7
	1.5	0.4	1.0	1000	33.5	22.2	1.03	32.5	37.0	70.0	1.2	6.0	2.5	5.7	1000	17.2	1.58	3.2	11.8	85.9	16.1	1.7
30	1.8	0.5	1.1	880	32.8	20.8	1.01	32.5	36.3	70.0	1.2	3.0	0.9	2.1	880	18.9	1.65	3.4	13.4	89.8	21.1	1.8
	1.8	0.5	1.1	1000	33.5	22.2	1.03	32.5	37.0	70.0	1.2	3.0	0.9	2.1	1000	19.1	1.58	3.5	13.7	87.7	20.8	1.8
	1.8	0.5	1.1	880	32.8	20.8	1.01	32.5	36.3	70.0	1.2	4.5	1.5	3.5	880	19.9	1.64	3.6	14.4	90.9	23.6	1.9
	1.8	0.5	1.1	1000	33.5	22.2	1.03	32.5	37.0	70.0	1.2	4.5	1.5	3.5	1000	20.2	1.57	3.8	14.8	88.7	23.4	1.9
	1.8	0.5	1.1	880	32.8	20.8	1.01	32.5	36.3	70.0	1.2	6.0	2.2	5.1	880	20.4	1.64	3.7	14.9	91.5	25.0	2.0
	1.8	0.5	1.1	1000	33.5	22.2	1.03	32.5	37.0	70.0	1.2	6.0	2.2	5.1	1000	20.7	1.57	3.9	15.4	89.2	24.9	2.0
40	2.4	0.6	1.4	880	32.8	20.8	1.01	32.5	36.3	70.0	1.2	3.0	0.8	1.9	880	21.9	1.64	3.9	16.4	93.1	29.1	2.1
	2.5	0.6	1.5	1000	33.5	22.2	1.03	32.5	37.0	70.0	1.2	3.0	0.8	1.9	1000	22.2	1.57	4.2	16.9	90.6	28.8	2.1
	2.4	0.6	1.4	880	32.8	20.8	1.01	32.5	36.3	70.0	1.2	4.5	1.4	3.2	880	23.1	1.64	4.1	17.6	94.3	32.2	2.2
	2.5	0.6	1.5	1000	33.5	22.2	1.03	32.5	37.0	70.0	1.2	4.5	1.4	3.2	1000	23.5	1.57	4.4	18.1	91.7	32.0	2.2
	2.4	0.6	1.4	880	32.8	20.8	1.01	32.5	36.3	70.0	1.2	6.0	2.0	4.7	880	23.8	1.64	4.3	18.3	95.1	33.9	2.3
	2.5	0.6	1.5	1000	33.5	22.2	1.03	32.5	37.0	70.0	1.2	6.0	2.0	4.7	1000	24.1	1.57	4.5	18.8	92.4	33.7	2.3
50	3.0	0.8	1.8	880	32.3	20.7	1.08	29.9	36.0	74.0	1.4	3.0	0.8	1.8	880	24.9	1.64	4.5	19.4	96.2	37.1	2.4
	3.0	0.8	1.8	1000	33.0	22.2	1.10	30.0	36.7	74.5	1.4	3.0	0.8	1.8	1000	25.3	1.57	4.7	19.9	93.4	36.7	2.4
	3.6	1.0	2.3	880	32.8	20.8	1.01	32.5	36.3	70.0	1.2	4.5	1.3	3.0	880	26.3	1.64	4.7	20.7	97.7	40.8	2.5
	3.7	1.0	2.4	1000	33.5	22.2	1.03	32.5	37.0	70.0	1.2	4.5	1.3	3.0	1000	26.7	1.57	5.0	21.3	94.7	40.5	2.5
	3.6	1.0	2.3	880	32.8	20.8	1.01	32.5	36.3	70.0	1.2	6.0	1.9	4.4	880	27.1	1.64	4.8	21.5	98.5	42.8	2.6
	3.7	1.0	2.4	1000	33.5	22.2	1.03	32.5	37.0	70.0	1.2	6.0	1.9	4.4	1000	27.5	1.57	5.1	22.1	95.4	42.6	2.6
60	3.0	0.8	1.8	880	30.8	20.2	1.24	24.9	35.0	83.3	2.0	3.0	0.8	1.8	880	27.9	1.65	5.0	22.3	99.3	45.2	2.6
	3.0	0.8	1.8	1000	31.4	21.6	1.26	24.9	35.7	83.8	2.0	3.0	0.8	1.8	1000	28.3	1.58	5.2	22.9	96.2	44.7	2.6
	4.5	1.3	2.9	880	32.1	20.6	1.11	28.9	35.9	75.9	1.5	4.5	1.3	2.9	880	29.5	1.65	5.2	23.8	101.0	49.4	2.7
	4.5	1.3	2.9	1000	32.7	22.1	1.13	29.0	36.6	76.3	1.5	4.5	1.3	2.9	1000	29.9	1.58	5.5	24.5	97.7	49.1	2.8
	6.0	1.8	4.2	880	32.6	20.8	1.05	31.0	36.2	72.1	1.3	6.0	1.8	4.2	880	30.4	1.65	5.4	24.7	102.0	51.8	2.7
	6.0	1.8	4.2	1000	33.2	22.2	1.07	31.1	36.9	72.3	1.3	6.0	1.8	4.2	1000	30.8	1.58	5.7	25.4	98.5	51.5	2.8
70	3.0	0.8	1.8	880	28.8	19.4	1.41	20.4	33.6	92.4	2.6	3.0	0.8	1.8	880	30.8	1.66	5.4	25.2	102.4	53.2	2.8
	3.0	0.8	1.8	1000	29.4	20.7	1.44	20.4	34.3	92.8	2.7	3.0	0.8	1.8	1000	31.3	1.59	5.8	25.9	99.0	52.8	2.9
	4.5	1.2	2.9	880	30.4	20.0	1.28	23.8	34.7	85.4	2.1	4.5	1.2	2.9	880	32.7	1.67	5.7	27.0	104.4	58.0	2.9
	4.5	1.2	2.9	1000	31.0	21.4	1.30	23.8	35.4	85.7	2.1	4.5	1.2	2.9	1000	33.2	1.60	6.1	27.7	100.7	57.7	3.0
	6.0	1.8	4.1	880	31.1	20.3	1.21	25.8	35.2	81.7	1.9	6.0	1.8	4.1	880	33.7	1.67	5.9	28.0	105.5	60.7	3.0
	6.0	1.8	4.1	1000	31.7	21.7	1.23	25.8	35.9	82.0	1.9	6.0	1.8	4.1	1000	34.2	1.60	6.3	28.7	101.7	60.4	3.1
80	3.0	0.8	1.9	880	26.6	18.4	1.61	16.5	32.1	101.4	3.6	3.0	0.8	1.9	880	33.9	1.67	5.9	28.1	105.6	61.3	3.0
	3.0	0.8	1.9	1000	27.1	19.7	1.64	16.5	32.7	101.8	3.7	3.0	0.8	1.9	1000	34.3	1.60	6.3	28.9	101.8	60.8	3.1
	4.5	1.2	2.9	880	28.3	19.1	1.46	19.3	33.2	94.8	2.9	4.0	1.1	2.5	880	35.5	1.69	6.2	29.7	107.4	65.0	3.1
	4.5	1.2	2.9	1000	28.8	20.5	1.49	19.3	33.9	95.1	3.0	4.1	1.1	2.6	1000	36.0	1.62	6.5	30.5	103.4	65.0	3.2
	6.0	1.7	4.0	880	29.1	19.5	1.38	21.0	33.8	91.3	2.6	4.0	1.1	2.5	880	35.5	1.69	6.2	29.7	107.4	65.0	3.1
	6.0	1.7	4.0	1000	29.7	20.9	1.41	21.0	34.5	91.5	2.6	4.1	1.1	2.6	1000	36.0	1.62	6.5	30.5	103.4	65.0	3.2
90	3.0	0.8	1.9	880	24.4	17.4	1.84	13.3	30.7	110.4	4.7	2.4	0.7	1.5	880	35.5	1.69	6.2	29.7	107.4	65.0	3.1
	3.0	0.8	1.9	1000	24.9	18.7	1.87	13.3	31.3	110.8	4.8	2.4	0.7	1.6	1000	36.0	1.62	6.5	30.5	103.4	65.0	3.2
	4.5	1.2	2.9	880	26.0	18.1	1.67	15.6	31.7	104.1	3.9	2.4	0.7	1.5	880	35.5	1.69	6.2	29.7	107.4	65.0	3.1
	4.5	1.2	2.9	1000	26.5	19.4	1.70	15.6	32.3	104.3	4.0	2.4	0.7	1.6	1000	36.0	1.62	6.5	30.5	103.4	65.0	3.2
	6.0	1.7	4.0	880	26.8	18.5	1.59	16.9	32.2	100.7	3.5	2.4	0.7	1.5	880	35.5	1.69	6.2	29.7	107.4	65.0	3.1
	6.0	1.7	4.0	1000	27.3	19.8	1.62	16.9	32.9	101.0	3.6	2.4	0.7	1.6	1000	36.0	1.62	6.5	30.5	103.4	65.0	3.2
100	3.0	0.8	1.9	880	22.5	16.6	2.09	10.7	29.6	119.7	6.1	1.7	0.5	1.2	880	35.5	1.69	6.2	29.7	107.4	65.0	3.1
	3.0	0.8	1.9	1000	22.9	17.8	2.13	10.7	30.1	120.1	6.2	1.7	0.5	1.2	1000	36.0	1.62	6.5	30.5	103.4	65.0	3.2
	4.5	1.2	2.8	880	23.8	17.1	1.91	12.5	30.3	113.5	5.1	1.7	0.5	1.2	880	35.5	1.69	6.2	29.7	107.4	65.0	3.1
	4.5	1.2	2.8	1000	24.2	18.4	1.94	12.5	30.9	113.7	5.2	1.7	0.5	1.2	1000	36.0	1.62	6.5	30.5	103.4	65.0	3.2
	6.0	1.7	3.9	880	24.5	17.5	1.83	13.4	30.7	110.2	4.6	1.7	0.5	1.2	880	35.5	1.69	6.2	29.7	107.4	65.0	3.1
	6.0	1.7	3.9	1000	25.0	18.7	1.86	13.4	31.3	110.4	4.7	1.7	0.5	1.2	1000	36.0	1.62	6.5	30.5	103.4	65.0	3.2
110	3.0	0.8	1.8	880	21.0	16.3	2.39	8.8	29.1	129.4	7.7	1.3	0.4	0.9	880	35.5	1.69	6.2	29.7	107.4	65.0	3.1
	3.0	0.8	1.8	1000	21.4	17.4	2.43	8.8	29.7	129.8	7.8	1.4	0.4	0.9	1000	36.0	1.62	6.5	30.5	103.4	65.0	3.2
	4.5	1.2	2.8	880	21.9	16.4	2.19	10.0	29.3	123.0	6.6	1.3	0.4	0.9	880	35.5	1.69	6.2	29.7	107.4	65.0	3.1
	4.5	1.2	2.8	1000	22.3	17.6	2.23	10.0	29.9	123.3	6.7	1.4	0.4	0.9	1000	36.0	1.62	6.5	30.5	103.4	65.0	3.2
	6.0	1.7	3.8	880	22.5	16.6	2.09	10.7	29.6	119.9	6.0	1.3	0.4	0.9	880	35.5	1.69	6.2	29.7	107.4	65.0	3.1
	6.0	1.7	3.8	1000	22.9	17.8	2.13	10.7	30.2	120.1	6.1	1.4	0.4	0.9	1000	36.0	1.62	6.5	30.5	103.4	65.0	3.2
120	3.0	0.7	1.7	880	20.4	16.8	2.75	7.4	29.8	139.9	9.6	1.1	0.3	0.6	880	35.5	1.69	6.2	29.7	107.4	65.0	3.1
	3.0	0.7	1.7	1000	20.8	17.9	2.80	7.4	30.4	140.2	9.8	1.1	0.3	0.6	1000	36.0	1.62	6.5	30.5	103.4	65.0	3.2
	4.5	1.1	2.6	880	20.7	16.3	2.50	8.3	29.2	133.0	8.2	1.1	0.3	0.6	880	35.5	1.69	6.2	29.7	107.4	65.0	3.1
	4.5	1.1	2.6	1000	21.1	17.5	2.55	8.3	29.8	133.2	8.4	1.1	0.3	0.6	1000	36.0	1.62	6.5	30.5	103.4	65.0	3.2
	6.0	1.6	3.7	880	21.0	16.3	2.40	8.8	29.1	129.7	7.7											

# Performance Data — Tranquility® 30 Model 038 - Full Load, with vFlow®

Performance capacities shown in thousands of Btuh

Antifreeze use recommended in this range.  
Also Clip JW3 on DXM2.5 board.

EWT °F	Cooling - EAT 80/67 °F										Heating - EAT 70°F											
	GPM	WPD		CFM	TC	SC	kW	EER	HR	LWT	HWC	GPM	WPD		CFM	HC	kW	COP	HE	LAT	LWT	HWC
		PSI	FT										PSI	FT								
20	2.0	0.6	1.5	1100	44.2	26.6	1.70	26.0	49.9	70.0	1.8	9.0	4.3	9.9	1100	25.2	2.23	3.3	17.8	91.2	16.1	2.0
	2.0	0.7	1.5	1250	45.0	28.6	1.76	25.6	51.0	70.0	1.8	9.0	4.3	9.9	1250	25.6	2.16	3.5	18.2	89.0	15.9	2.1
30	2.5	0.7	1.7	1100	44.2	26.6	1.70	26.0	49.9	70.0	1.8	4.5	1.5	3.5	1100	27.7	2.25	3.6	20.1	93.3	21.0	2.3
	2.5	0.7	1.7	1250	45.0	28.6	1.76	25.6	51.0	70.0	1.8	4.5	1.5	3.5	1250	28.1	2.18	3.8	20.7	90.8	20.8	2.4
	2.5	0.7	1.7	1100	44.2	26.6	1.70	26.0	49.9	70.0	1.8	6.8	2.6	6.1	1100	29.0	2.26	3.8	21.4	94.4	23.7	2.5
	2.5	0.7	1.7	1250	45.0	28.6	1.76	25.6	51.0	70.0	1.8	6.8	2.6	6.1	1250	29.5	2.19	3.9	22.0	91.8	23.5	2.5
	2.5	0.7	1.7	1100	44.2	26.6	1.70	26.0	49.9	70.0	1.8	9.0	3.9	9.1	1100	29.7	2.26	3.9	22.1	95.0	25.1	2.6
	2.5	0.7	1.7	1250	45.0	28.6	1.76	25.6	51.0	70.0	1.8	9.0	3.9	9.1	1250	30.2	2.19	4.0	22.7	92.4	25.0	2.6
40	3.3	0.9	2.2	1100	44.2	26.6	1.70	26.0	49.9	70.0	1.8	4.5	1.4	3.2	1100	31.8	2.28	4.1	24.0	96.7	29.3	2.8
	3.4	1.0	2.2	1250	45.0	28.6	1.76	25.6	51.0	70.0	1.8	4.5	1.4	3.2	1250	32.2	2.21	4.3	24.7	93.9	29.0	2.9
	3.3	0.9	2.2	1100	44.2	26.6	1.70	26.0	49.9	70.0	1.8	6.8	2.4	5.6	1100	33.3	2.30	4.2	25.5	98.1	32.5	3.0
	3.4	1.0	2.2	1250	45.0	28.6	1.76	25.6	51.0	70.0	1.8	6.8	2.4	5.6	1250	33.8	2.23	4.4	26.2	95.1	32.3	3.1
	3.3	0.9	2.2	1100	44.2	26.6	1.70	26.0	49.9	70.0	1.8	9.0	3.6	8.4	1100	34.2	2.31	4.3	26.3	98.8	34.1	3.1
	3.4	1.0	2.2	1250	45.0	28.6	1.76	25.6	51.0	70.0	1.8	9.0	3.6	8.4	1250	34.7	2.24	4.5	27.1	95.7	34.0	3.2
50	4.5	1.3	3.0	1100	43.9	26.6	1.74	25.3	49.7	72.1	2.0	4.5	1.3	3.0	1100	35.8	2.33	4.5	27.9	100.1	37.6	3.3
	4.5	1.3	3.0	1250	44.6	28.6	1.80	24.8	50.8	72.6	2.0	4.5	1.3	3.0	1250	36.3	2.26	4.7	28.6	96.9	37.3	3.4
	5.0	1.5	3.4	1100	44.2	26.6	1.70	26.0	49.9	70.0	1.8	6.8	2.3	5.2	1100	37.6	2.36	4.7	29.6	101.6	41.3	3.5
	5.1	1.5	3.5	1250	45.0	28.6	1.76	25.6	51.0	70.0	1.8	6.8	2.3	5.2	1250	38.2	2.29	4.9	30.3	98.3	41.1	3.6
	5.0	1.5	3.4	1100	44.2	26.6	1.70	26.0	49.9	70.0	1.8	9.0	3.4	7.9	1100	38.6	2.38	4.7	30.5	102.5	43.2	3.6
	5.1	1.5	3.5	1250	45.0	28.6	1.76	25.6	51.0	70.0	1.8	9.0	3.4	7.9	1250	39.2	2.31	5.0	31.3	99.0	43.0	3.7
60	4.5	1.3	2.9	1100	42.3	26.1	1.90	22.3	48.7	81.7	2.6	4.5	1.3	2.9	1100	39.8	2.40	4.9	31.6	103.5	45.9	3.7
	4.5	1.3	2.9	1250	43.0	28.1	1.97	21.9	49.8	82.1	2.7	4.5	1.3	2.9	1250	40.4	2.33	5.1	32.5	99.9	45.6	3.8
	6.8	2.1	4.9	1100	43.5	26.5	1.78	24.5	49.5	74.6	2.1	6.8	2.2	5.0	1100	41.9	2.45	5.0	33.5	105.2	50.1	4.0
	6.8	2.1	4.9	1250	44.3	28.5	1.84	24.1	50.6	75.0	2.2	6.8	2.2	5.0	1250	42.5	2.37	5.3	34.4	101.5	49.9	4.1
	9.0	3.3	7.5	1100	44.0	26.6	1.72	25.6	49.8	71.1	1.9	9.0	3.3	7.5	1100	43.0	2.47	5.1	34.6	106.2	52.3	4.1
	9.0	3.3	7.5	1250	44.8	28.6	1.78	25.2	50.9	71.3	1.9	9.0	3.3	7.5	1250	43.7	2.39	5.4	35.5	102.3	52.1	4.2
70	4.5	1.2	2.9	1100	40.4	25.4	2.07	19.5	47.4	91.1	3.4	4.5	1.2	2.9	1100	43.9	2.49	5.2	35.4	106.9	54.3	4.2
	4.5	1.2	2.9	1250	41.1	27.4	2.15	19.1	48.4	91.5	3.5	4.5	1.2	2.9	1250	44.5	2.41	5.4	36.3	103.0	53.9	4.3
	6.8	2.1	4.8	1100	41.8	26.0	1.95	21.5	48.4	84.2	2.8	6.8	2.1	4.8	1100	46.2	2.55	5.3	37.5	108.9	59.0	4.5
	6.8	2.1	4.8	1250	42.6	27.9	2.02	21.1	49.4	84.6	2.9	6.8	2.1	4.8	1250	46.9	2.47	5.6	38.5	104.8	58.7	4.6
	9.0	3.1	7.2	1100	42.5	26.2	1.88	22.6	48.8	80.9	2.5	9.0	3.1	7.2	1100	47.6	2.58	5.4	38.7	110.0	61.4	4.6
	9.0	3.1	7.2	1250	43.2	28.2	1.95	22.2	49.9	81.1	2.6	9.0	3.1	7.2	1250	48.3	2.50	5.7	39.8	105.8	61.2	4.7
80	4.5	1.2	2.9	1100	38.2	24.6	2.29	16.7	45.9	100.4	4.3	4.5	1.2	2.9	1100	48.0	2.59	5.4	39.2	110.4	62.6	4.6
	4.5	1.2	2.9	1250	38.8	26.4	2.37	16.4	46.9	100.9	4.4	4.5	1.2	2.9	1250	48.8	2.51	5.7	40.2	106.1	62.1	4.7
	6.8	2.0	4.7	1100	39.8	25.2	2.13	18.6	47.0	93.8	3.6	5.4	1.5	3.5	1100	49.5	2.63	5.5	40.5	111.7	65.0	4.8
	6.8	2.0	4.7	1250	40.5	27.1	2.21	18.3	48.0	94.2	3.7	5.5	1.6	3.6	1250	50.3	2.55	5.8	41.6	107.3	65.0	4.9
	9.0	3.1	7.1	1100	40.5	25.5	2.07	19.6	47.5	90.6	3.3	5.4	1.5	3.5	1100	49.5	2.63	5.5	40.5	111.7	65.0	4.8
	9.0	3.1	7.1	1250	41.2	27.4	2.14	19.3	48.5	90.8	3.4	5.5	1.6	3.6	1250	50.3	2.55	5.8	41.6	107.3	65.0	4.9
90	4.5	1.2	2.9	1100	35.8	23.6	2.54	14.1	44.4	109.7	5.3	3.2	0.9	2.0	1100	49.5	2.63	5.5	40.5	111.7	65.0	4.8
	4.5	1.2	2.9	1250	36.4	25.4	2.63	13.8	45.4	110.2	5.5	3.3	0.9	2.1	1250	50.3	2.55	5.8	41.6	107.3	65.0	4.9
	6.8	2.0	4.6	1100	37.4	24.3	2.36	15.8	45.5	103.4	4.6	3.2	0.9	2.0	1100	49.5	2.63	5.5	40.5	111.7	65.0	4.8
	6.8	2.0	4.6	1250	38.1	26.1	2.45	15.5	46.4	103.8	4.7	3.3	0.9	2.1	1250	50.3	2.55	5.8	41.6	107.3	65.0	4.9
	9.0	3.0	6.9	1100	38.3	24.6	2.28	16.8	46.0	100.2	4.3	3.2	0.9	2.0	1100	49.5	2.63	5.5	40.5	111.7	65.0	4.8
	9.0	3.0	6.9	1250	38.9	26.5	2.36	16.5	47.0	100.4	4.3	3.3	0.9	2.1	1250	50.3	2.55	5.8	41.6	107.3	65.0	4.9
100	4.5	1.2	2.8	1100	33.3	22.5	2.83	11.8	43.0	119.1	6.5	2.3	0.7	1.5	1100	49.5	2.63	5.5	40.5	111.7	65.0	4.8
	4.5	1.2	2.8	1250	33.9	24.2	2.93	11.6	43.9	119.5	6.7	2.4	0.7	1.5	1250	50.3	2.55	5.8	41.6	107.3	65.0	4.9
	6.8	2.0	4.5	1100	35.0	23.2	2.62	13.3	43.9	112.9	5.7	2.3	0.7	1.5	1100	49.5	2.63	5.5	40.5	111.7	65.0	4.8
	6.8	2.0	4.5	1250	35.6	25.0	2.72	13.1	44.9	113.3	5.9	2.4	0.7	1.5	1250	50.3	2.55	5.8	41.6	107.3	65.0	4.9
	9.0	3.0	6.8	1100	35.8	23.6	2.54	14.1	44.4	109.9	5.3	2.3	0.7	1.5	1100	49.5	2.63	5.5	40.5	111.7	65.0	4.8
	9.0	3.0	6.8	1250	36.4	25.4	2.63	13.9	45.4	110.1	5.5	2.4	0.7	1.5	1250	50.3	2.55	5.8	41.6	107.3	65.0	4.9
110	4.5	1.2	2.8	1100	30.9	21.4	3.17	9.7	41.7	128.5	7.9	1.8	0.5	1.2	1100	49.5	2.63	5.5	40.5	111.7	65.0	4.8
	4.5	1.2	2.8	1250	31.4	23.0	3.29	9.5	42.6	128.9	8.0	1.8	0.5	1.2	1250	50.3	2.55	5.8	41.6	107.3	65.0	4.9
	6.8	1.9	4.5	1100	32.4	22.1	2.94	11.0	42.5	122.5	7.0	1.8	0.5	1.2	1100	49.5	2.63	5.5	40.5	111.7	65.0	4.8
	6.8	1.9	4.5	1250	33.0	23.8	3.05	10.8	43.4	122.9	7.1	1.8	0.5	1.2	1250	50.3	2.55	5.8	41.6	107.3	65.0	4.9
	9.0	2.9	6.7	1100	33.3	22.5	2.84	11.7	42.9	119.5	6.6	1.8	0.5	1.2	1100	49.5	2.63	5.5	40.5	111.7	65.0	4.8
	9.0	2.9	6.7	1250	33.8	24.2	2.94	11.5	43.9	119.7	6.7	1.8	0.5	1.2	1250	50.3	2.55	5.8	41.6	107.3	65.0	4.9
120	4.5	1.1	2.6	1100	28.5	20.3	3.59	7.9	40.8	138.1	9.4	1.5	0.4	0.8	1100	49.5	2.63	5.5	40.5	111.7	65.0	4.8
	4.5	1.1	2.6	1250	29.0	21.9	3.72	7.8	41.7	138.5	9.6	1.5	0.4	0.8	1250	50.3	2.55	5.8	41.6	107.3	65.0	4.9
	6.8	1.9	4.3	1100	29.9	21.0	3.32	9.0	41.3	132.2	8.4	1.5	0.4	0.8	1100	49.5	2.63	5.5	40.5	111.7	65.0	4.8
	6.8	1.9	4.3	1250	30.5	22.6	3.44	8.9	42.2	132.5	8.6	1.5	0.4	0.8	1250	50.3	2.55	5.8	41.6	107.3	65.0	

Performance Data — Tranquility® 30 Model 049 - Part Load, with vFlow®

Performance capacities shown in thousands of Btu/h

EWT °F	Cooling - EAT 80/67 °F										Antifreeze use recommended in this range. Also Clip JW3 on DXM2.5 board. Heating - EAT 70°F											
	GPM	WPD		CFM	TC	SC	kW	EER	HR	LWT	HWC	GPM	WPD		CFM	HC	kW	COP	HE	LAT	LWT	HWC
		PSI	FT										PSI	FT								
20	1.8	0.1	0.1	1190	41.3	27.9	1.42	29.0	46.2	70.0	1.5	9.0	2.3	5.4	1190	22.8	2.38	2.8	14.9	87.7	16.7	2.5
	1.9	0.1	0.1	1350	42.1	29.9	1.45	29.0	47.1	70.0	1.5	9.0	2.3	5.4	1350	23.1	2.28	3.0	15.3	85.8	16.6	2.5
30	2.3	0.1	0.1	1190	41.3	27.9	1.42	29.0	46.2	70.0	1.5	4.5	0.2	0.6	1190	25.0	2.35	3.1	17.2	89.4	22.4	2.6
	2.4	0.1	0.1	1350	42.1	29.9	1.45	29.0	47.1	70.0	1.5	4.5	0.2	0.6	1350	25.3	2.25	3.3	17.6	87.4	22.2	2.6
	2.3	0.1	0.1	1190	41.3	27.9	1.42	29.0	46.2	70.0	1.5	6.8	1.2	2.8	1190	25.9	2.34	3.3	18.1	90.2	24.7	2.6
	2.4	0.1	0.1	1350	42.1	29.9	1.45	29.0	47.1	70.0	1.5	6.8	1.2	2.8	1350	26.3	2.24	3.4	18.6	88.0	24.5	2.6
	2.3	0.1	0.1	1190	41.3	27.9	1.42	29.0	46.2	70.0	1.5	9.0	2.1	4.9	1190	26.5	2.34	3.3	18.7	90.6	25.9	2.6
	2.4	0.1	0.1	1350	42.1	29.9	1.45	29.0	47.1	70.0	1.5	9.0	2.1	4.9	1350	26.8	2.24	3.5	19.2	88.4	25.7	2.6
40	3.1	0.1	0.1	1190	41.3	27.9	1.42	29.0	46.2	70.0	1.5	4.5	0.2	0.4	1190	28.5	2.33	3.6	20.8	92.2	30.8	2.6
	3.1	0.1	0.1	1350	42.1	29.9	1.45	29.0	47.1	70.0	1.5	4.5	0.2	0.4	1350	28.9	2.23	3.8	21.3	89.8	30.5	2.7
	3.1	0.1	0.1	1190	41.3	27.9	1.42	29.0	46.2	70.0	1.5	6.8	1.1	2.5	1190	29.8	2.33	3.8	22.0	93.2	33.5	2.6
	3.1	0.1	0.1	1350	42.1	29.9	1.45	29.0	47.1	70.0	1.5	6.8	1.1	2.5	1350	30.2	2.23	4.0	22.6	90.7	33.3	2.7
	3.1	0.1	0.1	1190	41.3	27.9	1.42	29.0	46.2	70.0	1.5	9.0	2.0	4.6	1190	30.5	2.32	3.9	22.7	93.7	35.0	2.6
	3.1	0.1	0.1	1350	42.1	29.9	1.45	29.0	47.1	70.0	1.5	9.0	2.0	4.6	1350	30.9	2.22	4.1	23.3	91.2	34.8	2.7
50	4.5	0.1	0.3	1190	41.2	28.0	1.44	28.6	46.1	70.5	1.5	4.5	0.1	0.3	1190	32.3	2.32	4.1	24.5	95.2	39.1	2.7
	4.5	0.1	0.3	1350	42.0	30.0	1.47	28.6	47.0	70.9	1.5	4.5	0.1	0.3	1350	32.8	2.22	4.3	25.2	92.5	38.8	2.8
	4.6	0.2	0.4	1190	41.3	27.9	1.42	29.0	46.2	70.0	1.5	6.8	1.0	2.4	1190	33.9	2.33	4.3	26.1	96.4	42.3	2.8
	4.7	0.2	0.5	1350	42.1	29.9	1.45	29.0	47.1	70.0	1.5	6.8	1.0	2.4	1350	34.4	2.23	4.5	26.8	93.6	42.1	2.9
	4.6	0.2	0.4	1190	41.3	27.9	1.42	29.0	46.2	70.0	1.5	9.0	1.9	4.3	1190	34.8	2.33	4.4	26.9	97.1	44.0	2.8
	4.7	0.2	0.5	1350	42.1	29.9	1.45	29.0	47.1	70.0	1.5	9.0	1.9	4.3	1350	35.3	2.23	4.6	27.7	94.2	43.9	2.9
60	4.5	0.1	0.2	1190	39.8	27.8	1.66	24.0	45.5	80.2	2.1	4.5	0.1	0.2	1190	36.3	2.33	4.6	28.4	98.3	47.4	2.9
	4.5	0.1	0.2	1350	40.6	29.8	1.69	24.0	46.4	80.6	2.1	4.5	0.1	0.2	1350	36.8	2.23	4.8	29.2	95.3	47.0	3.0
	6.8	1.0	2.2	1190	40.9	28.0	1.50	27.2	46.0	73.5	1.7	6.8	1.0	2.2	1190	38.2	2.34	4.8	30.3	99.7	51.1	3.0
	6.8	1.0	2.2	1350	41.7	30.0	1.53	27.2	46.9	73.9	1.7	6.8	1.0	2.2	1350	38.7	2.24	5.1	31.1	96.6	50.9	3.1
	9.0	1.8	4.2	1190	41.3	28.0	1.43	28.8	46.2	70.3	1.5	9.0	1.8	4.2	1190	39.2	2.35	4.9	31.3	100.5	53.1	3.0
	9.0	1.8	4.2	1350	42.1	29.9	1.46	28.8	47.0	70.5	1.5	9.0	1.8	4.2	1350	39.8	2.25	5.2	32.1	97.3	52.9	3.1
70	4.5	0.1	0.2	1190	37.9	27.1	1.91	19.9	44.4	89.7	2.7	4.5	0.1	0.2	1190	40.4	2.35	5.0	32.4	101.4	55.6	3.1
	4.5	0.1	0.2	1350	38.6	29.0	1.94	19.9	45.2	90.1	2.8	4.5	0.1	0.2	1350	41.0	2.25	5.3	33.3	98.1	55.2	3.2
	6.8	0.9	2.1	1190	39.3	27.7	1.73	22.7	45.2	83.3	2.3	6.8	0.9	2.2	1190	42.6	2.36	5.3	34.5	103.1	59.8	3.2
	6.8	0.9	2.1	1350	40.0	29.6	1.76	22.7	46.1	83.6	2.3	6.8	0.9	2.2	1350	43.2	2.26	5.6	35.5	99.6	59.6	3.3
	9.0	1.8	4.0	1190	39.9	27.9	1.65	24.2	45.5	80.1	2.1	9.0	1.8	4.0	1190	43.8	2.37	5.4	35.7	104.1	62.1	3.3
	9.0	1.8	4.0	1350	40.7	29.8	1.68	24.2	46.4	80.3	2.1	9.0	1.8	4.0	1350	44.4	2.27	5.7	36.7	100.5	61.9	3.4
80	4.5	0.1	0.3	1190	35.5	26.0	2.18	16.3	42.9	99.1	3.7	4.5	0.1	0.3	1190	44.6	2.37	5.5	36.4	104.7	63.8	3.3
	4.5	0.1	0.3	1350	36.2	27.8	2.22	16.3	43.7	99.4	3.8	4.5	0.1	0.3	1350	45.2	2.27	5.8	37.4	101.0	63.4	3.4
	6.8	0.9	2.1	1190	37.1	26.7	1.99	18.6	43.9	92.9	3.0	5.0	0.1	0.2	1190	45.4	2.38	5.6	37.2	105.3	65.0	3.4
	6.8	0.9	2.1	1350	37.8	28.6	2.03	18.6	44.7	93.3	3.1	5.1	0.3	0.8	1350	46.0	2.28	5.9	38.3	101.6	65.0	3.5
	9.0	1.7	3.9	1190	37.9	27.1	1.91	19.9	44.4	89.9	3.3	5.0	0.3	0.7	1190	45.4	2.38	5.6	37.2	105.3	65.0	3.6
	9.0	1.7	3.9	1350	38.6	29.0	1.94	19.9	45.2	90.0	3.4	5.1	0.3	0.8	1350	46.0	2.28	5.9	38.3	101.6	65.0	3.7
90	4.5	0.1	0.3	1190	32.9	24.7	2.49	13.2	41.4	108.4	4.8	3.0	0.1	0.1	1190	45.4	2.38	5.6	37.2	105.3	65.0	3.4
	4.5	0.1	0.3	1350	33.5	26.5	2.54	13.2	42.2	108.7	4.9	3.1	0.1	0.1	1350	46.0	2.28	5.9	38.3	101.6	65.0	3.5
	6.8	0.9	2.1	1190	34.6	25.5	2.29	15.1	42.4	102.5	4.0	3.0	0.1	0.1	1190	45.4	2.38	5.6	37.2	105.3	65.0	3.4
	6.8	0.9	2.1	1350	35.2	27.3	2.33	15.1	43.2	102.8	4.1	3.1	0.1	0.1	1350	46.0	2.28	5.9	38.3	101.6	65.0	3.5
	9.0	1.7	3.9	1190	35.4	25.9	2.19	16.2	42.9	99.5	3.7	3.0	0.1	0.1	1190	45.4	2.38	5.6	37.2	105.3	65.0	3.4
	9.0	1.7	3.9	1350	36.1	27.8	2.23	16.2	43.7	99.7	3.8	3.1	0.1	0.1	1350	46.0	2.28	5.9	38.3	101.6	65.0	3.5
100	4.5	0.1	0.3	1190	30.2	23.5	2.84	10.6	39.9	117.7	6.1	2.1	0.1	0.1	1190	45.4	2.38	5.6	37.2	105.3	65.0	3.4
	4.5	0.1	0.3	1350	30.8	25.2	2.89	10.7	40.7	118.1	6.2	2.2	0.1	0.1	1350	46.0	2.28	5.9	38.3	101.6	65.0	3.5
	6.8	0.9	2.1	1190	31.9	24.3	2.62	12.2	40.8	112.0	5.3	2.1	0.1	0.1	1190	45.4	2.38	5.6	37.2	105.3	65.0	3.4
	6.8	0.9	2.1	1350	32.5	26.0	2.67	12.2	41.6	112.3	5.4	2.2	0.1	0.1	1350	46.0	2.28	5.9	38.3	101.6	65.0	3.5
	9.0	1.7	3.8	1190	32.7	24.6	2.51	13.0	41.3	109.2	4.9	2.1	0.1	0.1	1190	45.4	2.38	5.6	37.2	105.3	65.0	3.4
	9.0	1.7	3.8	1350	33.3	26.4	2.56	13.0	42.1	109.3	5.0	2.2	0.1	0.1	1350	46.0	2.28	5.9	38.3	101.6	65.0	3.5
110	4.5	0.1	0.2	1190	27.7	22.6	3.24	8.5	38.7	127.2	7.6	1.7	0.1	0.1	1190	45.4	2.38	5.6	37.2	105.3	65.0	3.4
	4.5	0.1	0.2	1350	28.2	24.2	3.30	8.5	39.5	127.5	7.7	1.7	0.1	0.1	1350	46.0	2.28	5.9	38.3	101.6	65.0	3.5
	6.8	0.9	2.0	1190	29.2	23.1	3.00	9.7	39.4	121.6	6.7	1.7	0.1	0.1	1190	45.4	2.38	5.6	37.2	105.3	65.0	3.4
	6.8	0.9	2.0	1350	29.7	24.7	3.05	9.7	40.1	121.9	6.8	1.7	0.1	0.1	1350	46.0	2.28	5.9	38.3	101.6	65.0	3.5
	9.0	1.6	3.7	1190	30.0	23.4	2.88	10.4	39.8	118.8	6.2	1.7	0.1	0.1	1190	45.4	2.38	5.6	37.2	105.3	65.0	3.4
	9.0	1.6	3.7	1350	30.5	25.1	2.93	10.4	40.5	119.0	6.3	1.7	0.1	0.1	1350	46.0	2.28	5.9	38.3	101.6	65.0	3.5
120	4.5	0.1	0.1	1190	25.4	22.0	3.68	6.9	38.0	136.9	9.3	1.4	0.1	0.1	1190	45.4	2.38	5.6	37.2	105.3	65.0	3.4
	4.5	0.1	0.1	1350	25.9	23.6	3.75	6.9	38.7	137.2	9.5	1.4	0.1	0.1	1350	46.0	2.28	5.9	38.3	101.6	65.0	3.5
	6.8	0.8	1.9	1190	26.7	22.3	3.42	7.8	38.3	131.3	8.2	1.4	0.1	0.1	1190	45.4	2.38	5.6	37.2	105.3	65.0	3.4
	6.8	0.8	1.9	1350	27.2	23.9																

Performance Data — Tranquility® 30 Model 049 - Full Load, with vFlow®

Performance capacities shown in thousands of Btuh

Antifreeze use recommended in this range.  
Also Clip JW3 on DXM2.5 board.

EWT °F	Cooling - EAT 80/67 °F										Heating - EAT 70°F											
	GPM	WPD		CFM	TC	SC	kW	EER	HR	LWT	HWC	GPM	WPD		CFM	HC	kW	COP	HE	LAT	LWT	HWC
		PSI	FT										PSI	FT								
20	2.5	0.1	0.2	1360	54.0	33.1	2.26	23.9	61.6	70.0	2.3	12.0	4.1	9.4	1450	31.4	3.17	2.9	20.9	90.1	16.5	3.3
	2.5	0.1	0.2	1550	54.9	35.6	2.34	23.5	62.9	70.0	2.3	12.0	4.1	9.4	1650	31.9	3.07	3.0	21.4	87.9	16.4	3.3
30	3.1	0.1	0.2	1360	54.0	33.1	2.26	23.9	61.6	70.0	2.3	6.0	0.9	2.1	1450	34.7	3.16	3.2	24.2	92.2	21.9	3.4
	3.1	0.1	0.2	1550	54.9	35.6	2.34	23.5	62.9	70.0	2.3	6.0	0.9	2.1	1650	35.3	3.06	3.4	24.8	89.8	21.7	3.5
	3.1	0.1	0.2	1360	54.0	33.1	2.26	23.9	61.6	70.0	2.3	9.0	2.1	4.9	1450	36.2	3.16	3.4	25.7	93.1	24.3	3.5
	3.1	0.1	0.2	1550	54.9	35.6	2.34	23.5	62.9	70.0	2.3	9.0	2.1	4.9	1650	36.8	3.06	3.5	26.3	90.6	24.1	3.5
	3.1	0.1	0.2	1360	54.0	33.1	2.26	23.9	61.6	70.0	2.3	12.0	3.8	8.8	1450	37.1	3.16	3.4	26.5	93.7	25.6	3.5
	3.1	0.1	0.2	1550	54.9	35.6	2.34	23.5	62.9	70.0	2.3	12.0	3.8	8.8	1650	37.6	3.06	3.6	27.2	91.1	25.5	3.6
40	4.1	0.2	0.5	1360	54.0	33.1	2.26	23.9	61.6	70.0	2.3	6.0	0.8	1.8	1450	39.9	3.18	3.7	29.2	95.5	30.3	3.6
	4.2	0.2	0.5	1550	54.9	35.6	2.34	23.5	62.9	70.0	2.3	6.0	0.8	1.8	1650	40.5	3.08	3.9	30.0	92.7	30.0	3.7
	4.1	0.2	0.5	1360	54.0	33.1	2.26	23.9	61.6	70.0	2.3	9.0	2.0	4.6	1450	41.7	3.21	3.8	30.9	96.6	33.1	3.7
	4.2	0.2	0.5	1550	54.9	35.6	2.34	23.5	62.9	70.0	2.3	9.0	2.0	4.6	1650	42.3	3.11	4.0	31.7	93.8	32.9	3.8
	4.1	0.2	0.5	1360	54.0	33.1	2.26	23.9	61.6	70.0	2.3	12.0	3.6	8.4	1450	42.7	3.22	3.9	31.8	97.3	34.7	3.8
	4.2	0.2	0.5	1550	54.9	35.6	2.34	23.5	62.9	70.0	2.3	12.0	3.6	8.4	1650	43.3	3.12	4.1	32.7	94.3	34.6	3.9
50	6.0	0.7	1.7	1360	54.0	33.2	2.29	23.6	61.7	70.6	2.3	6.0	0.7	1.7	1450	45.0	3.26	4.0	34.0	98.8	38.7	3.9
	6.0	0.7	1.7	1550	54.9	35.7	2.37	23.2	63.0	71.0	2.3	6.0	0.7	1.7	1650	45.7	3.16	4.2	34.9	95.7	38.4	4.0
	6.2	0.8	1.8	1360	54.0	33.1	2.26	23.9	61.6	70.0	2.3	9.0	1.9	4.3	1450	47.2	3.30	4.2	36.0	100.1	42.0	4.1
	6.3	0.8	1.9	1550	54.9	35.6	2.34	23.5	62.9	70.0	2.3	9.0	1.9	4.3	1650	47.9	3.20	4.4	37.0	96.9	41.8	4.1
	6.2	0.8	1.8	1360	54.0	33.1	2.26	23.9	61.6	70.0	2.3	12.0	3.5	8.0	1450	48.3	3.33	4.2	37.1	100.9	43.8	4.1
	6.3	0.8	1.9	1550	54.9	35.6	2.34	23.5	62.9	70.0	2.3	12.0	3.5	8.0	1650	49.1	3.23	4.5	38.1	97.5	43.7	4.2
60	6.0	0.7	1.6	1360	53.1	33.6	2.52	21.1	61.6	80.5	2.9	6.0	0.7	1.6	1450	50.2	3.37	4.4	38.8	102.1	47.1	4.3
	6.0	0.7	1.6	1550	54.0	36.1	2.61	20.7	62.9	81.0	2.9	6.0	0.7	1.6	1650	51.0	3.27	4.6	39.8	98.6	46.7	4.4
	9.0	1.8	4.2	1360	53.9	33.4	2.35	22.9	61.8	73.7	2.4	9.0	1.8	4.2	1450	52.7	3.44	4.5	41.0	103.6	50.9	4.4
	9.0	1.8	4.2	1550	54.8	36.0	2.44	22.5	63.1	74.0	2.5	9.0	1.8	4.2	1650	53.5	3.33	4.7	42.1	100.0	50.6	4.5
	12.0	3.4	7.8	1360	54.0	33.1	2.27	23.8	61.6	70.3	2.3	12.0	3.4	7.8	1450	54.0	3.48	4.5	42.2	104.5	53.0	4.5
	12.0	3.4	7.8	1550	54.9	35.6	2.35	23.4	63.0	70.5	2.3	12.0	3.4	7.8	1650	54.8	3.37	4.8	43.3	100.8	52.8	4.6
70	6.0	0.7	1.5	1360	51.0	33.0	2.78	18.3	60.4	90.1	3.6	6.0	0.7	1.5	1450	55.5	3.52	4.6	43.5	105.4	55.5	4.6
	6.0	0.7	1.5	1550	51.9	35.5	2.88	18.0	61.7	90.6	3.7	6.0	0.7	1.5	1650	56.3	3.41	4.8	44.7	101.6	55.1	4.7
	9.0	1.8	4.0	1360	52.6	33.5	2.60	20.2	61.3	83.6	3.1	9.0	1.8	4.0	1450	58.2	3.60	4.7	46.0	107.2	59.8	4.9
	9.0	1.8	4.0	1550	53.5	36.0	2.69	19.9	62.7	83.9	3.1	9.0	1.8	4.0	1650	59.1	3.49	5.0	47.2	103.2	59.5	5.0
	12.0	3.3	7.6	1360	53.2	33.6	2.51	21.2	61.6	80.3	2.8	12.0	3.3	7.6	1450	59.7	3.64	4.8	47.3	108.1	62.1	5.0
	12.0	3.3	7.6	1550	54.1	36.1	2.60	20.8	63.0	80.5	2.9	12.0	3.3	7.6	1650	60.6	3.53	5.0	48.6	104.0	61.9	5.1
80	6.0	0.7	1.5	1360	48.1	31.8	3.07	15.7	58.6	99.5	4.5	6.0	0.7	1.5	1450	60.7	3.67	4.8	48.2	108.8	63.9	5.1
	6.0	0.7	1.5	1550	49.0	34.2	3.18	15.4	59.8	99.9	4.6	6.0	0.7	1.5	1650	61.6	3.56	5.1	49.5	104.6	63.5	5.2
	9.0	1.7	4.0	1360	50.1	32.7	2.87	17.5	59.9	93.3	3.8	6.5	0.8	1.9	1450	61.6	3.70	4.9	49.0	109.4	65.0	5.2
	9.0	1.7	4.0	1550	51.0	35.1	2.97	17.2	61.1	93.6	3.9	6.7	0.9	2.1	1650	62.6	3.59	5.1	50.3	105.1	65.0	5.3
	12.0	3.2	7.5	1360	51.1	33.0	2.77	18.4	60.4	90.1	3.6	6.5	0.8	1.9	1450	61.6	3.70	4.9	49.0	109.4	65.0	5.2
	12.0	3.2	7.5	1550	51.9	35.5	2.87	18.1	61.7	90.3	3.6	6.7	0.9	2.1	1650	62.6	3.59	5.1	50.3	105.1	65.0	5.3
90	6.0	0.7	1.5	1360	44.9	30.2	3.40	13.2	56.5	108.8	4.8	3.9	0.1	0.2	1450	61.6	3.70	4.9	49.0	109.4	65.0	5.2
	6.0	0.7	1.5	1550	45.7	32.5	3.52	13.0	57.7	109.2	4.9	4.0	0.1	0.2	1650	62.6	3.59	5.1	50.3	105.1	65.0	5.3
	9.0	1.7	3.9	1360	47.1	31.3	3.17	14.8	57.9	102.9	4.5	3.9	0.1	0.2	1450	61.6	3.70	4.9	49.0	109.4	65.0	5.2
	9.0	1.7	3.9	1550	47.9	33.6	3.29	14.6	59.1	103.1	4.6	4.0	0.1	0.2	1650	62.6	3.59	5.1	50.3	105.1	65.0	5.3
	12.0	3.2	7.4	1360	48.1	31.8	3.07	15.7	58.5	99.8	5.6	3.9	0.1	0.2	1450	61.6	3.70	4.9	49.0	109.4	65.0	5.2
	12.0	3.2	7.4	1550	49.0	34.2	3.18	15.4	59.8	100.0	5.7	4.0	0.1	0.2	1650	62.6	3.59	5.1	50.3	105.1	65.0	5.3
100	6.0	0.6	1.5	1360	41.7	28.6	3.77	11.1	54.6	118.2	5.9	2.8	0.1	0.2	1450	61.6	3.70	4.9	49.0	109.4	65.0	5.2
	6.0	0.6	1.5	1550	42.5	30.8	3.91	10.9	55.8	118.6	6.0	2.9	0.1	0.2	1650	62.6	3.59	5.1	50.3	105.1	65.0	5.3
	9.0	1.7	3.8	1360	43.7	29.6	3.52	12.4	55.8	112.4	5.6	2.8	0.1	0.2	1450	61.6	3.70	4.9	49.0	109.4	65.0	5.2
	9.0	1.7	3.8	1550	44.5	31.8	3.65	12.2	57.0	112.7	5.7	2.9	0.1	0.2	1650	62.6	3.59	5.1	50.3	105.1	65.0	5.3
	12.0	3.2	7.3	1360	44.8	30.1	3.41	13.2	56.4	109.4	6.8	2.8	0.1	0.2	1450	61.6	3.70	4.9	49.0	109.4	65.0	5.2
	12.0	3.2	7.3	1550	45.6	32.4	3.53	12.9	57.6	109.6	7.0	2.9	0.1	0.2	1650	62.6	3.59	5.1	50.3	105.1	65.0	5.3
110	6.0	0.6	1.4	1360	38.9	27.3	4.23	9.2	53.4	127.8	7.3	2.2	0.1	0.2	1450	61.6	3.70	4.9	49.0	109.4	65.0	5.2
	6.0	0.6	1.4	1550	39.5	29.3	4.38	9.0	54.5	128.2	7.4	2.2	0.1	0.2	1650	62.6	3.59	5.1	50.3	105.1	65.0	5.3
	9.0	1.6	3.7	1360	40.6	28.0	3.95	10.3	54.0	122.0	6.8	2.2	0.1	0.2	1450	61.6	3.70	4.9	49.0	109.4	65.0	5.2
	9.0	1.6	3.7	1550	41.3	30.2	4.09	10.1	55.2	122.3	7.0	2.2	0.1	0.2	1650	62.6	3.59	5.1	50.3	105.1	65.0	5.3
	12.0	3.1	7.2	1360	41.5	28.5	3.80	10.9	54.5	119.1	8.3	2.2	0.1	0.2	1450	61.6	3.70	4.9	49.0	109.4	65.0	5.2
	12.0	3.1	7.2	1550	42.2	30.6	3.94	10.7	55.7	119.3	8.4	2.2	0.1	0.2	1650	62.6	3.59	5.1	50.3	105.1	65.0	5.3
120	6.0	0.6	1.3	1360	36.8	26.6	4.79	7.7	53.2	137.7	8.8	1.8	0.1	0.2	1450	61.6	3.70	4.9	49.0	109.4	65.0	5.2
	6.0	0.6	1.3	1550	37.4	28.6	4.96	7.5	54.3	138.1	9.0	1.8	0.1	0.2	1650	62.6	3.59	5.1	50.3	105.1	65.0	5.3
	9.0	1.6	3.6	1360	37.9	26.9	4.44	8.5	53.1	131.8	8.3	1.8	0.1	0.2	1450	61.6	3.70	4.9	49.0	109.4	65.0	5.2
	9.0	1.6	3.6	1550	38.6	28.9	4.60	8.4	54.3	132.1	8.5	1.8	0.1	0.2	1650	62.6	3.59	5.1	50.3			



## Performance Data — Tranquility® 30 Model 064 - Part Load, with vFlow®

Performance capacities shown in thousands of Btu/h

EWT °F	Cooling - EAT 80/67 °F											Antifreeze use recommended in this range. Also Clip JW3 on DXM2.5 board.										
												Heating - EAT 70°F										
	GPM	WPD		CFM	TC	SC	kW	EER	HR	LWT	HWC	GPM	WPD		CFM	HC	kW	COP	HE	LAT	LWT	HWC
	PSI	FT										PSI	FT									
20	2.4	0.1	0.1	1360	53.8	37.2	1.80	29.8	59.9	70.0	1.8	12.0	5.2	11.9	1450	28.2	2.87	2.9	18.7	88.0	16.9	3.1
	2.4	0.1	0.1	1550	54.8	39.9	1.84	29.9	61.1	70.0	1.8	12.0	5.2	11.9	1650	28.6	2.75	3.1	19.3	86.1	16.8	3.1
30	3.0	0.1	0.1	1360	53.8	37.2	1.80	29.8	59.9	70.0	1.8	6.0	0.9	2.1	1450	31.7	2.88	3.2	22.1	90.2	22.6	3.1
	3.1	0.1	0.1	1550	54.8	39.9	1.84	29.9	61.1	70.0	1.8	6.0	0.9	2.1	1650	32.2	2.76	3.4	22.7	88.0	22.4	3.2
	3.0	0.1	0.1	1360	53.8	37.2	1.80	29.8	59.9	70.0	1.8	9.0	2.5	5.7	1450	33.1	2.89	3.4	23.5	91.1	24.8	3.2
	3.1	0.1	0.1	1550	54.8	39.9	1.84	29.9	61.1	70.0	1.8	9.0	2.5	5.7	1650	33.6	2.77	3.6	24.1	88.8	24.6	3.2
	3.0	0.1	0.1	1360	53.8	37.2	1.80	29.8	59.9	70.0	1.8	12.0	4.1	9.6	1450	33.9	2.89	3.4	24.2	91.6	26.0	3.2
	3.1	0.1	0.1	1550	54.8	39.9	1.84	29.9	61.1	70.0	1.8	12.0	4.1	9.6	1650	34.4	2.77	3.6	24.9	89.3	25.8	3.2
40	4.0	0.1	0.1	1360	53.8	37.2	1.80	29.8	59.9	70.0	1.8	6.0	0.5	1.1	1450	37.0	2.91	3.7	27.3	93.6	30.9	3.2
	4.1	0.1	0.2	1550	54.8	39.9	1.84	29.9	61.1	70.0	1.8	6.0	0.5	1.1	1650	37.6	2.79	3.9	28.0	91.1	30.7	3.3
	4.0	0.1	0.2	1360	53.8	37.2	1.80	29.8	59.9	70.0	1.8	9.0	1.9	4.3	1450	38.8	2.92	3.9	29.0	94.8	33.6	3.3
	4.1	0.1	0.2	1550	54.8	39.9	1.84	29.9	61.1	70.0	1.8	9.0	1.9	4.3	1650	39.4	2.80	4.1	29.8	92.1	33.4	3.4
	4.0	0.1	0.2	1360	53.8	37.2	1.80	29.8	59.9	70.0	1.8	12.0	3.4	7.9	1450	39.8	2.93	4.0	30.0	95.4	35.0	3.3
	4.1	0.1	0.2	1550	54.8	39.9	1.84	29.9	61.1	70.0	1.8	12.0	3.4	7.9	1650	40.4	2.81	4.2	30.8	92.7	34.9	3.4
50	6.0	0.2	0.6	1360	53.7	37.2	1.81	29.6	59.9	70.0	1.8	6.0	0.2	0.6	1450	42.5	2.95	4.2	32.6	97.1	39.1	3.4
	6.0	0.2	0.6	1550	54.8	39.8	1.85	29.7	61.1	70.4	1.8	6.0	0.2	0.6	1650	43.1	2.82	4.5	33.5	94.2	38.8	3.5
	6.0	0.2	0.5	1360	53.8	37.2	1.80	29.8	59.9	70.0	1.8	9.0	1.5	3.5	1450	44.7	2.96	4.4	34.7	98.5	42.3	3.5
	6.1	0.3	0.7	1550	54.8	39.9	1.84	29.9	61.1	70.0	1.8	9.0	1.5	3.5	1650	45.3	2.84	4.7	35.7	95.4	42.1	3.5
	6.0	0.2	0.5	1360	53.8	37.2	1.80	29.8	59.9	70.0	1.8	12.0	3.0	6.9	1450	45.9	2.97	4.5	35.9	99.3	44.0	3.5
	6.1	0.3	0.7	1550	54.8	39.9	1.84	29.9	61.1	70.0	1.8	12.0	3.0	6.9	1650	46.6	2.85	4.8	36.9	96.1	43.9	3.6
60	6.0	0.2	0.4	1360	51.4	36.3	2.07	24.8	58.5	79.5	2.4	6.0	0.2	0.4	1450	48.1	2.99	4.7	37.9	100.7	47.4	3.6
	6.0	0.2	0.4	1550	52.4	38.9	2.11	24.8	59.6	79.9	2.5	6.0	0.2	0.4	1650	48.8	2.86	5.0	39.0	97.4	47.0	3.7
	9.0	1.4	3.1	1360	53.0	36.9	1.89	28.0	59.5	73.2	2.0	9.0	1.4	3.1	1450	50.6	3.01	4.9	40.4	102.3	51.0	3.7
	9.0	1.4	3.1	1550	54.1	39.5	1.93	28.1	60.6	73.5	2.0	9.0	1.4	3.1	1650	51.4	2.89	5.2	41.5	98.8	50.8	3.8
	12.0	2.7	6.3	1360	53.8	37.2	1.81	29.7	59.9	70.0	1.8	12.0	2.7	6.3	1450	52.1	3.02	5.0	41.7	103.2	53.0	3.8
	12.0	2.7	6.3	1550	54.8	39.9	1.84	29.8	61.1	70.2	1.8	12.0	2.7	6.3	1650	52.8	2.90	5.3	42.9	99.6	52.8	3.8
70	6.0	0.2	0.4	1360	48.6	35.4	2.38	20.4	56.7	88.9	3.3	6.0	0.2	0.4	1450	53.6	3.04	5.2	43.3	104.2	55.6	3.8
	6.0	0.2	0.4	1550	49.6	37.9	2.42	20.4	57.8	89.3	3.3	6.0	0.2	0.4	1650	54.4	2.91	5.5	44.5	100.5	55.2	3.9
	9.0	1.3	3.0	1360	50.5	36.0	2.17	23.2	57.9	82.9	2.7	9.0	1.3	3.0	1450	56.5	3.07	5.4	46.0	106.1	59.8	4.0
	9.0	1.3	3.0	1550	51.5	38.6	2.21	23.3	59.0	83.1	2.7	9.0	1.3	3.0	1650	57.3	2.94	5.7	47.3	102.2	59.5	4.1
	12.0	2.6	6.0	1360	51.4	36.3	2.07	24.8	58.5	79.7	2.4	12.0	2.6	6.0	1450	58.1	3.08	5.5	47.5	107.1	62.1	4.1
	12.0	2.6	6.0	1550	52.4	38.9	2.11	24.8	59.6	79.9	2.5	12.0	2.6	6.0	1650	58.9	2.96	5.8	48.8	103.1	61.9	4.2
80	6.0	0.2	0.6	1360	45.6	34.3	2.73	16.7	54.9	98.3	4.3	6.0	0.3	0.6	1450	59.1	3.10	5.6	48.5	107.7	63.8	4.1
	6.0	0.2	0.6	1550	46.5	36.7	2.78	16.7	56.0	98.7	4.4	6.0	0.3	0.6	1650	59.9	2.97	5.9	49.8	103.6	63.4	4.2
	9.0	1.3	3.1	1360	47.5	35.0	2.50	19.0	56.1	92.5	3.6	6.6	0.5	1.1	1450	60.2	3.11	5.7	49.5	108.4	65.0	4.2
	9.0	1.3	3.1	1550	48.5	37.5	2.55	19.0	57.2	92.7	3.7	6.8	0.5	1.2	1650	61.0	2.98	6.0	50.8	104.2	65.0	4.3
	12.0	2.6	5.9	1360	48.5	35.3	2.39	20.3	56.7	89.4	3.3	6.6	0.5	1.1	1450	60.2	3.11	5.7	49.5	108.4	65.0	4.2
	12.0	2.6	5.9	1550	49.5	37.8	2.44	20.3	57.8	89.6	3.4	6.8	0.5	1.2	1650	61.0	2.98	6.0	50.8	104.2	65.0	4.3
90	6.0	0.3	0.7	1360	42.4	33.0	3.13	13.6	53.1	107.7	5.5	4.0	0.2	0.5	1450	60.2	3.11	5.7	49.5	108.4	65.0	4.2
	6.0	0.3	0.7	1550	43.3	35.3	3.18	13.6	54.1	108.0	5.6	4.1	0.2	0.5	1650	61.0	2.98	6.0	50.8	104.2	65.0	4.3
	9.0	1.4	3.2	1360	44.4	33.8	2.88	15.4	54.2	102.0	4.7	4.0	0.2	0.5	1450	60.2	3.11	5.7	49.5	108.4	65.0	4.2
	9.0	1.4	3.2	1550	45.2	36.2	2.93	15.4	55.2	102.3	4.8	4.1	0.2	0.5	1650	61.0	2.98	6.0	50.8	104.2	65.0	4.3
	12.0	2.6	6.0	1360	45.4	34.2	2.76	16.4	54.8	99.1	4.4	4.0	0.2	0.5	1450	60.2	3.11	5.7	49.5	108.4	65.0	4.2
	12.0	2.6	6.0	1550	46.2	36.6	2.81	16.5	55.8	99.3	4.4	4.1	0.2	0.5	1650	61.0	2.98	6.0	50.8	104.2	65.0	4.3
100	6.0	0.3	0.8	1360	39.4	31.6	3.55	11.1	51.5	117.2	6.9	2.8	0.1	0.2	1450	60.2	3.11	5.7	49.5	108.4	65.0	4.2
	6.0	0.3	0.8	1550	40.2	33.9	3.62	11.1	52.5	117.5	7.0	2.9	0.1	0.2	1650	61.0	2.98	6.0	50.8	104.2	65.0	4.3
	9.0	1.4	3.2	1360	41.2	32.5	3.30	12.5	52.4	111.7	6.0	2.8	0.1	0.2	1450	60.2	3.11	5.7	49.5	108.4	65.0	4.2
	9.0	1.4	3.2	1550	42.0	34.7	3.36	12.5	53.4	111.9	6.1	2.9	0.1	0.2	1650	61.0	2.98	6.0	50.8	104.2	65.0	4.3
	12.0	2.6	6.0	1360	42.1	32.9	3.17	13.3	52.9	108.8	5.6	2.8	0.1	0.2	1450	60.2	3.11	5.7	49.5	108.4	65.0	4.2
	12.0	2.6	6.0	1550	43.0	35.2	3.23	13.3	54.0	109.0	5.7	2.9	0.1	0.2	1650	61.0	2.98	6.0	50.8	104.2	65.0	4.3
110	6.0	0.3	0.6	1360	36.7	30.2	4.02	9.1	50.4	126.8	8.5	2.2	0.1	0.1	1450	60.2	3.11	5.7	49.5	108.4	65.0	4.2
	6.0	0.3	0.6	1550	37.4	32.4	4.09	9.1	51.3	127.1	8.7	2.3	0.1	0.1	1650	61.0	2.98	6.0	50.8	104.2	65.0	4.3
	9.0	1.3	3.1	1360	38.2	31.0	3.75	10.2	51.0	121.3	7.5	2.2	0.1	0.1	1450	60.2	3.11	5.7	49.5	108.4	65.0	4.2
	9.0	1.3	3.1	1550	38.9	33.2	3.81	10.2	52.0	121.5	7.7	2.3	0.1	0.1	1650	61.0	2.98	6.0	50.8	104.2	65.0	4.3
	12.0	2.5	5.8	1360	39.0	31.4	3.61	10.8	51.4	118.6	7.1	2.2	0.1	0.1	1450	60.2	3.11	5.7	49.5	108.4	65.0	4.2
	12.0	2.5	5.8	1550	39.8	33.7	3.68	10.8	52.3	118.7	7.2	2.3	0.1	0.1	1650	61.0	2.98	6.0	50.8	104.2	65.0	4.3
120	6.0	0.0	0.0	1360	34.4	28.9	4.51	7.6	49.8	136.6	10.3	1.8	0.1	0.1	1450	60.2	3.11	5.7	49.5	108.4	65.0	4.2
	6.0	0.0	0.0	1550	35.1	31.0	4.59	7.6	50.8	136.9	10.5	1.8	0.1	0.1	1650	61.0	2.98	6.0	50.8	104.2	65.0	4.3
	9.0	1.1	2.6	1360	35.6	29.6	4.23	8.														

Performance Data — Tranquility® 30 Model 064 - Full Load, with vFlow®

Performance capacities shown in thousands of Btu/h

EWT °F	Cooling - EAT 80/67 °F										Antifreeze use recommended in this range. Also Clip JW3 on DXM2.5 board.											
	GPM	WPD		CFM	TC	SC	kW	EER	HR	LWT	HWC	GPM	WPD		CFM	HC	kW	COP	HE	LAT	LWT	HWC
		PSI	FT										PSI	FT								
20	3.3	0.2	0.4	1630	73.0	48.1	3.02	24.2	83.2	70.0	2.7	15.0	7.3	16.8	1800	42.8	3.89	3.2	29.8	92.0	16.0	3.8
	3.4	0.2	0.2	1850	74.3	51.7	3.13	23.7	85.0	70.0	2.8	15.0	7.3	16.8	2050	43.4	3.77	3.4	30.6	89.6	15.9	3.8
30	4.2	0.1	0.2	1630	73.0	48.1	3.02	24.2	83.2	70.0	2.7	7.5	1.7	3.9	1800	46.9	3.95	3.5	33.6	94.1	21.0	3.9
	4.2	0.1	0.2	1850	74.3	51.7	3.13	23.7	85.0	70.0	2.8	7.5	1.7	3.9	2050	47.6	3.82	3.6	34.5	91.5	20.8	4.0
	4.2	0.1	0.1	1630	73.0	48.1	3.02	24.2	83.2	70.0	2.7	11.3	3.7	8.6	1800	49.1	3.98	3.6	35.8	95.3	23.6	4.0
	4.2	0.1	0.1	1850	74.3	51.7	3.13	23.7	85.0	70.0	2.8	11.3	3.7	8.6	2050	49.9	3.86	3.8	36.7	92.5	23.5	4.1
	4.2	0.1	0.2	1630	73.0	48.1	3.02	24.2	83.2	70.0	2.7	15.0	6.1	14.1	1800	50.4	4.00	3.7	36.9	95.9	25.1	4.0
	4.2	0.1	0.2	1850	74.3	51.7	3.13	23.7	85.0	70.0	2.8	15.0	6.1	14.1	2050	51.2	3.88	3.9	37.9	93.1	24.9	4.1
40	5.5	0.3	0.6	1630	73.0	48.1	3.02	24.2	83.2	70.0	2.7	7.5	1.2	2.7	1800	53.9	4.06	3.9	40.2	97.7	29.3	4.2
	5.7	0.3	0.2	1850	74.3	51.7	3.13	23.7	85.0	70.0	2.8	7.5	1.2	2.7	2050	54.7	3.94	4.1	41.3	94.7	29.0	4.2
	5.5	0.3	0.6	1630	73.0	48.1	3.02	24.2	83.2	70.0	2.7	11.3	3.0	7.0	1800	56.7	4.12	4.0	42.8	99.2	32.4	4.3
	5.7	0.3	0.8	1850	74.3	51.7	3.13	23.7	85.0	70.0	2.8	11.3	3.0	7.0	2050	57.6	3.99	4.2	44.0	96.0	32.2	4.4
	5.5	0.3	0.6	1630	73.0	48.1	3.02	24.2	83.2	70.0	2.7	15.0	5.3	12.2	1800	58.3	4.15	4.1	44.3	100.0	34.1	4.3
	5.7	0.3	0.8	1850	74.3	51.7	3.13	23.7	85.0	70.0	2.8	15.0	5.3	12.2	2050	59.2	4.02	4.3	45.5	96.7	33.9	4.4
50	7.5	0.9	2.0	1630	72.4	47.8	3.08	23.5	82.8	72.1	2.8	7.5	0.9	2.0	1800	61.1	4.21	4.3	46.9	101.5	37.5	4.5
	7.5	0.9	2.0	1850	73.6	51.4	3.20	23.0	84.5	72.5	2.9	7.5	0.9	2.0	2050	62.1	4.08	4.5	48.2	98.0	37.2	4.6
	8.3	1.2	2.8	1630	73.0	48.1	3.02	24.2	83.2	70.0	2.7	11.3	2.6	6.0	1800	64.5	4.28	4.4	50.0	103.2	41.1	4.6
	8.5	1.3	3.0	1850	74.3	51.7	3.13	23.7	85.0	70.0	2.8	11.3	2.6	6.0	2050	65.5	4.15	4.6	51.3	99.6	40.9	4.7
	8.3	1.2	2.8	1630	73.0	48.1	3.02	24.2	83.2	70.0	2.7	15.0	4.7	10.8	1800	66.3	4.32	4.5	51.7	104.1	43.1	4.7
	8.5	1.3	3.0	1850	74.3	51.7	3.13	23.7	85.0	70.0	2.8	15.0	4.7	10.8	2050	67.3	4.19	4.7	53.0	100.4	42.9	4.8
60	7.5	0.7	1.7	1630	69.5	46.7	3.35	20.7	80.9	81.6	3.5	7.5	0.7	1.7	1800	68.5	4.37	4.6	53.6	105.2	45.7	4.9
	7.5	0.7	1.7	1850	70.7	50.3	3.47	20.4	82.6	82.0	3.6	7.5	0.7	1.7	2050	69.5	4.24	4.8	55.1	101.4	45.3	5.0
	11.3	2.4	5.4	1630	71.7	47.6	3.15	22.8	82.3	74.6	3.0	11.3	2.4	5.4	1800	72.3	4.46	4.7	57.1	107.2	49.8	5.1
	11.3	2.4	5.4	1850	73.0	51.1	3.26	22.4	84.1	75.0	3.1	11.3	2.4	5.4	2050	73.4	4.33	5.0	58.6	103.2	49.6	5.2
	15.0	4.3	10.0	1630	72.7	48.0	3.05	23.8	83.0	71.1	2.8	15.0	4.3	10.0	1800	74.4	4.52	4.8	59.0	108.3	52.1	5.2
	15.0	4.3	10.0	1850	74.0	51.6	3.16	23.4	84.8	71.3	2.8	15.0	4.3	10.0	2050	75.5	4.38	5.1	60.6	104.1	51.9	5.3
70	7.5	0.7	1.7	1630	66.1	45.5	3.67	18.0	78.6	91.0	4.4	7.5	0.7	1.7	1800	75.8	4.55	4.9	60.3	109.0	53.9	5.3
	7.5	0.7	1.7	1850	67.3	48.9	3.81	17.7	80.3	91.4	4.5	7.5	0.7	1.7	2050	77.0	4.41	5.1	61.9	104.8	53.5	5.4
	11.3	2.3	5.2	1630	68.6	46.4	3.43	20.0	80.3	84.2	3.8	11.3	2.3	5.2	1800	80.1	4.67	5.0	64.2	111.2	58.6	5.6
	11.3	2.3	5.2	1850	69.8	49.9	3.56	19.6	82.0	84.6	3.8	11.3	2.3	5.2	2050	81.3	4.52	5.3	65.9	106.7	58.3	5.7
	15.0	4.1	9.5	1630	69.9	46.9	3.32	21.0	81.1	80.8	3.5	15.0	4.1	9.5	1800	82.4	4.73	5.1	66.3	112.4	61.2	5.7
	15.0	4.1	9.5	1850	71.1	50.4	3.44	20.6	82.8	81.0	3.5	15.0	4.1	9.5	2050	83.7	4.59	5.3	68.0	107.8	60.9	5.8
80	7.5	0.8	1.8	1630	62.5	44.1	4.05	15.4	76.2	100.3	5.5	7.5	0.8	1.8	1800	83.1	4.75	5.1	66.9	112.8	62.2	5.8
	7.5	0.8	1.8	1850	63.5	47.5	4.19	15.1	77.8	100.8	5.6	7.5	0.8	1.8	2050	84.4	4.61	5.4	68.7	108.1	61.7	5.9
	11.3	2.2	5.2	1630	65.1	45.1	3.78	17.2	77.9	93.8	4.7	9.3	1.4	3.3	1800	86.0	4.84	5.2	69.5	114.3	65.0	6.0
	11.3	2.2	5.2	1850	66.2	48.5	3.91	16.9	79.6	94.1	4.8	9.5	1.5	3.6	2050	87.3	4.69	5.5	71.3	109.4	65.0	6.1
	15.0	4.1	9.4	1630	66.4	45.6	3.65	18.2	78.7	90.5	4.3	9.3	1.4	3.3	1800	86.0	4.84	5.2	69.5	114.3	65.0	6.0
	15.0	4.1	9.4	1850	67.5	49.0	3.78	17.9	80.4	90.7	4.4	9.5	1.5	3.6	2050	87.3	4.69	5.5	71.3	109.4	65.0	6.1
90	7.5	0.8	2.0	1630	58.7	42.6	4.49	13.1	74.0	109.7	6.7	5.6	0.2	0.4	1800	86.0	4.84	5.2	69.5	114.3	65.0	6.0
	7.5	0.8	2.0	1850	59.8	45.8	4.65	12.9	75.6	110.2	6.8	5.7	0.2	0.5	2050	87.3	4.69	5.5	71.3	109.4	65.0	6.1
	11.3	2.3	5.2	1630	61.3	43.7	4.18	14.7	75.5	103.4	5.8	5.6	0.2	0.4	1800	86.0	4.84	5.2	69.5	114.3	65.0	6.0
	11.3	2.3	5.2	1850	62.3	47.0	4.33	14.4	77.1	103.7	5.9	5.7	0.2	0.5	2050	87.3	4.69	5.5	71.3	109.4	65.0	6.1
	15.0	4.0	9.3	1630	62.6	44.2	4.03	15.5	76.3	100.2	5.4	5.6	0.2	0.4	1800	86.0	4.84	5.2	69.5	114.3	65.0	6.0
	15.0	4.0	9.3	1850	63.7	47.5	4.18	15.2	77.9	100.4	5.5	5.7	0.2	0.5	2050	87.3	4.69	5.5	71.3	109.4	65.0	6.1
100	7.5	0.9	2.0	1630	55.2	41.1	5.00	11.0	72.3	119.3	8.1	4.0	0.1	0.2	1800	86.0	4.84	5.2	69.5	114.3	65.0	6.0
	7.5	0.9	2.0	1850	56.2	44.2	5.18	10.8	73.9	119.7	8.3	4.1	0.1	0.2	2050	87.3	4.69	5.5	71.3	109.4	65.0	6.1
	11.3	2.3	5.2	1630	57.5	42.1	4.65	12.4	73.4	113.0	7.1	4.0	0.1	0.2	1800	86.0	4.84	5.2	69.5	114.3	65.0	6.0
	11.3	2.3	5.2	1850	58.5	45.3	4.82	12.1	75.0	113.3	7.3	4.1	0.1	0.2	2050	87.3	4.69	5.5	71.3	109.4	65.0	6.1
	15.0	4.0	9.3	1630	58.8	42.6	4.48	13.1	74.0	109.9	6.7	4.0	0.1	0.2	1800	86.0	4.84	5.2	69.5	114.3	65.0	6.0
	15.0	4.0	9.3	1850	59.8	45.9	4.65	12.9	75.6	110.1	6.8	4.1	0.1	0.2	2050	87.3	4.69	5.5	71.3	109.4	65.0	6.1
110	7.5	0.8	1.8	1630	52.2	39.6	5.60	9.3	71.4	129.0	9.8	3.1	0.1	0.1	1800	86.0	4.84	5.2	69.5	114.3	65.0	6.0
	7.5	0.8	1.8	1850	53.1	42.6	5.80	9.2	72.9	129.4	10.0	3.2	0.1	0.1	2050	87.3	4.69	5.5	71.3	109.4	65.0	6.1
	11.3	2.2	5.1	1630	54.1	40.6	5.20	10.4	71.9	122.7	8.7	3.1	0.1	0.1	1800	86.0	4.84	5.2	69.5	114.3	65.0	6.0
	11.3	2.2	5.1	1850	55.0	43.6	5.39	10.2	73.4	123.1	8.8	3.2	0.1	0.1	2050	87.3	4.69	5.5	71.3	109.4	65.0	6.1
	15.0	4.0	9.2	1630	55.2	41.1	5.01	11.0	72.3	119.6	8.2	3.1	0.1	0.1	1800	86.0	4.84	5.2	69.5	114.3	65.0	6.0
	15.0	4.0	9.2	1850	56.1	44.2	5.19	10.8	73.8	119.8	8.3	3.2	0.1	0.1	2050	87.3	4.69	5.5	71.3	109.4	65.0	6.1
120	7.5	0.6	1.3	1630	50.0	38.5	6.30	7.9	71.6	139.1	11.7	2.5	0.1	0.1	1800	86.0	4.84	5.2	69.5	114.3	65.0	6.0
	7.5	0.6	1.3	1850	50.8	41.4	6.53	7.8	73.1	139.5	11.9	2.6	0.1	0.1	2050	87.3	4.69	5.5	71.3	109.4	65.0	6.1
	11.3	2.0	4.7	1630	51.3	39.2	5.83	8.8	71.3	132.6	10.4	2.5	0.1	0.1	1800	86.0	4.84	5.2	69.5	114.3		

Performance Data — Tranquility® 30 Model 072 - Part Load, with vFlow®

Performance capacities shown in thousands of Btu/h

EWT °F	Cooling - EAT 80/67 °F										Antifreeze use recommended in this range. Also Clip JW3 on DXM2.5 board. Heating - EAT 70°F											
	GPM	WPD		CFM	TC	SC	kW	EER	HR	LWT	HWC	GPM	WPD		CFM	HC	kW	COP	HE	LAT	LWT	HWC
		PSI	FT										PSI	FT								
20	2.8	0.1	0.2	1360	61.8	39.2	2.27	27.2	69.5	70.0	2.6	14.0	6.5	15.1	1450	32.9	3.66	2.6	20.9	91.0	17.0	4.1
	2.8	0.1	0.2	1550	63.0	42.0	2.31	27.2	70.9	70.0	2.7	14.0	6.5	15.1	1650	33.4	3.51	2.8	21.4	88.7	16.9	4.1
30	3.5	0.1	0.2	1360	61.8	39.2	2.27	27.2	69.5	70.0	2.6	7.0	1.4	3.3	1450	37.2	3.72	2.9	24.8	93.7	22.9	4.2
	3.5	0.1	0.2	1550	63.0	42.0	2.31	27.2	70.9	70.0	2.7	7.0	1.4	3.3	1650	37.7	3.57	3.1	25.5	91.1	22.7	4.3
	3.5	0.1	0.2	1360	61.8	39.2	2.27	27.2	69.5	70.0	2.6	10.5	3.3	7.6	1450	38.7	3.75	3.0	26.3	94.7	25.0	4.2
	3.5	0.1	0.2	1550	63.0	42.0	2.31	27.2	70.9	70.0	2.7	10.5	3.3	7.6	1650	39.3	3.59	3.2	27.0	92.0	24.9	4.3
	3.5	0.1	0.2	1360	61.8	39.2	2.27	27.2	69.5	70.0	2.6	14.0	5.4	12.5	1450	39.6	3.76	3.1	27.1	95.3	26.1	4.2
40	4.6	0.1	0.2	1360	61.8	39.2	2.27	27.2	69.5	70.0	2.6	7.0	0.9	2.2	1450	43.3	3.81	3.3	30.6	97.6	31.3	4.4
	4.7	0.2	0.4	1550	63.0	42.0	2.31	27.2	70.9	70.0	2.7	7.0	0.9	2.2	1650	43.9	3.65	3.5	31.4	94.6	31.0	4.5
	4.6	0.2	0.4	1360	61.8	39.2	2.27	27.2	69.5	70.0	2.6	10.5	2.6	6.1	1450	45.2	3.84	3.5	32.4	98.9	33.8	4.4
	4.7	0.2	0.4	1550	63.0	42.0	2.31	27.2	70.9	70.0	2.7	10.5	2.6	6.1	1650	45.8	3.68	3.7	33.3	95.7	33.7	4.5
	4.6	0.2	0.4	1360	61.8	39.2	2.27	27.2	69.5	70.0	2.6	14.0	4.6	10.7	1450	46.3	3.85	3.5	33.4	99.5	35.2	4.4
50	7.0	0.7	1.5	1360	61.7	39.2	2.28	27.1	69.5	69.9	2.6	7.0	0.7	1.5	1450	49.4	3.90	3.7	36.3	101.5	39.6	4.7
	7.0	0.7	1.5	1550	62.9	41.9	2.32	27.1	70.8	70.2	2.7	7.0	0.7	1.5	1650	50.1	3.74	3.9	37.4	98.1	39.3	4.8
	7.0	0.6	1.5	1360	61.8	39.2	2.27	27.2	69.5	70.0	2.6	10.5	2.2	5.1	1450	51.7	3.93	3.9	38.5	103.0	42.7	4.8
	7.1	0.7	1.6	1550	63.0	42.0	2.31	27.2	70.9	70.0	2.7	10.5	2.2	5.1	1650	52.5	3.77	4.1	39.6	99.4	42.5	4.9
	7.0	0.6	1.5	1360	61.8	39.2	2.27	27.2	69.5	70.0	2.6	14.0	4.1	9.4	1450	53.0	3.95	3.9	39.7	103.8	44.3	4.8
60	7.0	0.5	1.3	1360	59.1	38.1	2.60	22.7	68.0	79.4	3.2	7.0	0.5	1.3	1450	55.6	3.98	4.1	42.2	105.5	48.0	5.1
	7.0	0.5	1.3	1550	60.2	40.8	2.65	22.7	69.3	79.8	3.2	7.0	0.5	1.3	1650	56.4	3.82	4.3	43.3	101.6	47.6	5.2
	10.5	2.0	4.6	1360	60.9	38.8	2.38	25.6	69.0	73.1	2.8	10.5	2.0	4.6	1450	58.3	4.02	4.2	44.7	107.2	51.5	5.2
	10.5	2.0	4.6	1550	62.1	41.6	2.42	25.6	70.4	73.4	2.9	10.5	2.0	4.6	1650	59.1	3.86	4.5	46.0	103.2	51.2	5.3
	14.0	3.8	8.7	1360	61.8	39.2	2.28	27.1	69.5	69.9	2.7	14.0	3.8	8.7	1450	59.8	4.04	4.3	46.1	108.2	53.4	5.3
70	14.0	3.8	8.7	1550	63.0	42.0	2.32	27.2	70.9	70.1	2.7	14.0	3.8	8.7	1650	60.6	3.88	4.6	47.4	104.0	53.2	5.4
	7.0	0.5	1.3	1360	56.0	36.9	2.98	18.8	66.2	88.9	4.2	7.0	0.5	1.3	1450	61.8	4.07	4.4	48.0	109.4	56.3	5.5
	7.0	0.5	1.3	1550	57.1	39.5	3.04	18.8	67.5	89.3	4.3	7.0	0.5	1.3	1650	62.6	3.90	4.7	49.3	105.1	55.9	5.6
	10.5	1.9	4.5	1360	58.1	37.7	2.73	21.3	67.4	82.8	3.6	10.5	1.9	4.5	1450	64.8	4.12	4.6	50.9	111.4	60.3	5.7
	10.5	1.9	4.5	1550	59.2	40.3	2.78	21.3	68.7	83.1	3.7	10.5	1.9	4.5	1650	65.8	3.95	4.9	52.3	106.9	60.0	5.8
80	14.0	3.6	8.3	1360	59.1	38.1	2.61	22.7	67.9	79.7	3.4	14.0	3.6	8.3	1450	66.5	4.14	4.7	52.5	112.5	62.5	5.8
	14.0	3.6	8.3	1550	60.2	40.7	2.65	22.7	69.3	79.9	3.5	14.0	3.6	8.3	1650	67.5	3.97	5.0	53.9	107.9	62.3	5.9
	7.0	0.6	1.4	1360	52.7	35.6	3.42	15.4	64.3	98.4	5.7	7.0	0.6	1.4	1450	68.0	4.17	4.8	53.8	113.4	64.6	6.0
	7.0	0.6	1.4	1550	53.7	38.1	3.48	15.4	65.6	98.7	5.8	7.0	0.6	1.4	1650	68.9	3.99	5.1	55.3	108.7	64.2	6.1
	10.5	1.9	4.5	1360	54.8	36.4	3.13	17.5	65.5	92.5	4.9	7.2	0.7	1.6	1450	68.5	4.17	4.8	54.3	113.8	65.0	6.0
90	10.5	1.9	4.5	1550	55.9	39.0	3.19	17.5	66.8	92.7	5.0	7.4	0.8	1.8	1650	69.5	4.00	5.1	55.8	109.0	65.0	6.1
	14.0	3.5	8.1	1360	55.9	36.8	3.00	18.7	66.1	89.4	4.5	7.2	0.7	1.6	1450	68.5	4.17	4.8	54.3	113.8	65.0	6.0
	14.0	3.5	8.1	1550	57.0	39.4	3.05	18.7	67.4	89.6	4.6	7.4	0.8	1.8	1650	69.5	4.00	5.1	55.8	109.0	65.0	6.1
	7.0	0.7	1.5	1360	49.1	34.2	3.91	12.6	62.5	107.8	7.5	4.3	0.3	0.6	1450	68.5	4.17	4.8	54.3	113.8	65.0	6.0
	7.0	0.7	1.5	1550	50.1	36.6	3.98	12.6	63.7	108.2	7.6	4.5	0.3	0.6	1650	69.5	4.00	5.1	55.8	109.0	65.0	6.1
100	10.5	2.0	4.5	1360	51.3	35.0	3.60	14.3	63.6	102.1	6.5	4.3	0.3	0.6	1450	68.5	4.17	4.8	54.3	113.8	65.0	6.0
	10.5	2.0	4.5	1550	52.3	37.5	3.67	14.3	64.8	102.3	6.7	4.5	0.3	0.6	1650	69.5	4.00	5.1	55.8	109.0	65.0	6.1
	14.0	3.5	8.1	1360	52.4	35.5	3.45	15.2	64.2	99.2	6.1	4.3	0.3	0.6	1450	68.5	4.17	4.8	54.3	113.8	65.0	6.0
	14.0	3.5	8.1	1550	53.5	38.0	3.51	15.2	65.4	99.3	6.2	4.5	0.3	0.6	1650	69.5	4.00	5.1	55.8	109.0	65.0	6.1
	7.0	0.7	1.6	1360	45.5	32.9	4.45	10.2	60.7	117.4	9.7	3.1	0.2	0.4	1450	68.5	4.17	4.8	54.3	113.8	65.0	6.0
110	7.0	0.7	1.6	1550	46.4	35.2	4.54	10.2	61.9	117.7	9.9	3.2	0.2	0.4	1650	69.5	4.00	5.1	55.8	109.0	65.0	6.1
	10.5	2.0	4.5	1360	47.7	33.7	4.12	11.6	61.7	111.8	8.6	3.1	0.2	0.4	1450	68.5	4.17	4.8	54.3	113.8	65.0	6.0
	10.5	2.0	4.5	1550	48.6	36.0	4.20	11.6	62.9	112.0	8.8	3.2	0.2	0.4	1650	69.5	4.00	5.1	55.8	109.0	65.0	6.1
	14.0	3.5	8.1	1360	48.8	34.1	3.96	12.3	62.3	108.9	8.1	3.1	0.2	0.4	1450	68.5	4.17	4.8	54.3	113.8	65.0	6.0
	14.0	3.5	8.1	1550	49.7	36.5	4.03	12.3	63.5	109.1	8.2	3.2	0.2	0.4	1650	69.5	4.00	5.1	55.8	109.0	65.0	6.1
120	7.0	0.6	1.4	1360	42.0	31.5	5.06	8.3	59.3	126.9	12.4	2.4	0.1	0.2	1450	68.5	4.17	4.8	54.3	113.8	65.0	6.0
	7.0	0.6	1.4	1550	42.9	33.8	5.15	8.3	60.4	127.3	12.6	2.5	0.1	0.2	1650	69.5	4.00	5.1	55.8	109.0	65.0	6.1
	10.5	1.9	4.4	1360	44.1	32.3	4.70	9.4	60.1	121.4	11.1	2.4	0.1	0.2	1450	68.5	4.17	4.8	54.3	113.8	65.0	6.0
	10.5	1.9	4.4	1550	44.9	34.6	4.78	9.4	61.2	121.7	11.3	2.5	0.1	0.2	1650	69.5	4.00	5.1	55.8	109.0	65.0	6.1
	14.0	3.5	8.0	1360	45.1	32.7	4.52	10.0	60.5	118.6	10.5	2.4	0.1	0.2	1450	68.5	4.17	4.8	54.3	113.8	65.0	6.0
120	14.0	3.5	8.0	1550	46.0	35.0	4.61	10.0	61.7	118.8	10.7	2.5	0.1	0.2	1650	69.5	4.00	5.1	55.8	109.0	65.0	6.1
	7.0	0.4	0.9	1360	38.7	30.3	5.72	6.8	58.2	136.6	15.4	2.0	0.1	0.1	1450	68.5	4.17	4.8	54.3	113.8	65.0	6.0
	7.0	0.4	0.9	1550	39.5	32.5	5.82	6.8	59.4	137.0	15.7	2.0	0.1	0.1	1650	69.5	4.00	5.1	55.8	109.0	65.0	6.1
	10.5	1.7	3.9	1360	40.6	31.0	5.33	7.6	58.8	131.2	14.0	2.0	0.1	0.1	1450	68.5	4.17	4.8	54.3	113.8	65.0	6.0
	10.5	1.7	3.9	1550	41.4	33.2	5.43	7.6	59.9	131.4	14.3	2.0	0.1	0.1	1650	69.5	4.00	5.1	55.8	109.0	65.0	6.1
120	14.0	3.3	7.6	1360	41.6	31.3	5.14	8.1	59.1	128.4	13.3	2.0	0.1	0.1	1450	68.5	4.17	4.8	54.3	113.8	65.0	6.0
	14.0	3.3	7.6	1550	42.4	33.6	5.24	8.1	60.2	128.6	13.6	2.0	0.1	0.1	1650	69.5	4.00	5.1	55.8	109.0	65.0	6.1

Interpolation is permissible; extrapolation is not. All performance is based upon the lower voltage of dual voltage rated units.  
 Flow is controlled to maintain minimum LWT 70° F in cooling and maximum LWT 65° F in heating.  
 Operation at or below 40° F EWT is based on 15% methanol antifreeze solution. Table does not reflect fan or pump power corrections for AHRI/ISO conditions.

Performance Data — Tranquility® 30 Model 072 - Full Load, with vFlow®

Performance capacities shown in thousands of Btuh

EWT °F	Cooling - EAT 80/67 °F										Antifreeze use recommended in this range. Also Clip JW3 on DXM2.5board. Heating - EAT 70°F											
	GPM	WPD		CFM	TC	SC	kW	EER	HR	LWT	HWC	GPM	WPD		CFM	HC	kW	COP	HE	LAT	LWT	HWC
		PSI	FT										PSI	FT								
20	3.7	0.3	0.6	1630	79.6	49.1	3.49	22.8	91.3	70.0	4.4	17.0	8.9	20.6	1800	46.6	4.66	2.9	31.1	94.0	16.3	4.9
	3.7	0.3	0.6	1850	81.0	52.8	3.61	22.4	93.3	70.0	4.5	17.0	8.9	20.6	2050	47.3	4.52	3.1	31.9	91.4	16.2	5.0
30	4.6	0.2	0.5	1630	79.6	49.1	3.49	22.8	91.3	70.0	4.4	8.5	2.2	5.1	1800	51.6	4.77	3.2	35.6	96.5	21.6	5.1
	4.7	0.3	0.6	1850	81.0	52.8	3.61	22.4	93.3	70.0	4.5	8.5	2.2	5.1	2050	52.4	4.63	3.3	36.6	93.7	21.4	5.2
	4.6	0.2	0.5	1630	79.6	49.1	3.49	22.8	91.3	70.0	4.4	12.8	4.6	10.6	1800	54.0	4.83	3.3	37.8	97.8	24.1	5.3
	4.7	0.3	0.6	1850	81.0	52.8	3.61	22.4	93.3	70.0	4.5	12.8	4.6	10.6	2050	54.8	4.68	3.4	38.8	94.8	23.9	5.4
	4.6	0.3	0.5	1630	79.6	49.1	3.49	22.8	91.3	70.0	4.4	17.0	7.6	17.6	1800	55.3	4.86	3.3	39.0	98.4	25.4	5.3
40	6.1	0.5	1.2	1630	79.6	49.1	3.49	22.8	91.3	70.0	4.4	8.5	1.6	3.8	1800	59.4	4.96	3.5	42.7	100.5	29.9	5.6
	6.2	0.6	1.3	1850	81.0	52.8	3.61	22.4	93.3	70.0	4.5	8.5	1.6	3.8	2050	60.3	4.80	3.7	43.9	97.2	29.7	5.7
	6.1	0.5	1.2	1630	79.6	49.1	3.49	22.8	91.3	70.0	4.4	12.8	3.9	8.9	1800	62.1	5.02	3.6	45.3	102.0	32.9	5.8
	6.2	0.6	1.3	1850	81.0	52.8	3.61	22.4	93.3	70.0	4.5	12.8	3.9	8.9	2050	63.1	4.87	3.8	46.5	98.5	32.7	5.9
	6.1	0.5	1.2	1630	79.6	49.1	3.49	22.8	91.3	70.0	4.4	17.0	6.7	15.5	1800	63.6	5.06	3.7	46.6	102.7	34.5	5.9
50	8.5	1.3	3.0	1630	79.1	49.0	3.54	22.3	91.0	71.4	4.5	8.5	1.3	3.0	1800	66.9	5.14	3.8	49.6	104.4	38.3	6.2
	8.5	1.3	3.0	1850	80.5	52.6	3.67	21.9	93.0	71.9	4.6	8.5	1.3	3.0	2050	67.9	4.99	4.0	50.9	100.7	38.0	6.3
	9.1	1.6	3.7	1630	79.6	49.1	3.49	22.8	91.3	70.0	4.4	12.8	3.4	7.8	1800	70.1	5.23	3.9	52.5	106.1	41.8	6.5
	9.3	1.7	3.9	1850	81.0	52.8	3.61	22.4	93.3	70.0	4.5	12.8	3.4	7.8	2050	71.2	5.07	4.1	53.9	102.1	41.5	6.6
	9.1	1.6	3.7	1630	79.6	49.1	3.49	22.8	91.3	70.0	4.4	17.0	6.0	13.9	1800	71.8	5.27	4.0	54.0	106.9	43.6	6.6
60	8.5	1.2	2.7	1630	76.1	47.8	3.87	19.6	89.2	81.0	5.4	8.5	1.2	2.7	1800	74.4	5.34	4.1	56.4	108.3	46.7	6.9
	8.5	1.2	2.7	1850	77.4	51.4	4.01	19.3	91.1	81.4	5.6	8.5	1.2	2.7	2050	75.5	5.18	4.3	57.9	104.1	46.4	7.1
	12.8	3.1	7.1	1630	78.3	48.7	3.63	21.6	90.6	74.2	4.7	12.8	3.1	7.1	1800	78.0	5.44	4.2	59.6	110.1	50.7	7.3
	12.8	3.1	7.1	1850	79.7	52.3	3.76	21.2	92.5	74.5	4.8	12.8	3.1	7.1	2050	79.2	5.28	4.4	61.2	105.8	50.4	7.4
	17.0	5.6	13.0	1630	79.3	49.1	3.52	22.6	91.2	70.7	4.4	17.0	5.6	13.0	1800	80.0	5.50	4.3	61.4	111.1	52.8	7.5
70	8.5	1.1	2.6	1630	72.4	46.3	4.26	17.0	86.9	90.4	6.7	8.5	1.1	2.6	1800	81.9	5.56	4.3	63.1	112.1	55.2	7.7
	8.5	1.1	2.6	1850	73.7	49.8	4.42	16.7	88.7	90.9	6.8	8.5	1.1	2.6	2050	83.2	5.38	4.5	64.8	107.6	54.8	7.9
	12.8	3.0	6.8	1630	75.0	47.4	3.98	18.9	88.5	83.8	5.8	12.8	3.0	6.8	1800	86.0	5.68	4.4	66.7	114.2	59.5	8.2
	12.8	3.0	6.8	1850	76.3	50.9	4.12	18.5	90.4	84.2	5.9	12.8	3.0	6.8	2050	87.3	5.50	4.6	68.5	109.4	59.3	8.4
	17.0	5.4	12.4	1630	76.3	47.9	3.85	19.8	89.3	80.5	5.4	17.0	5.4	12.4	1800	88.2	5.75	4.5	68.7	115.4	61.9	8.5
80	8.5	1.2	2.7	1630	68.4	44.7	4.72	14.5	84.4	99.9	8.2	8.5	1.2	2.7	1800	89.5	5.79	4.5	69.9	116.0	63.6	8.7
	8.5	1.2	2.7	1850	69.5	48.1	4.89	14.2	86.2	100.3	8.4	8.5	1.2	2.7	2050	90.9	5.61	4.7	71.7	111.0	63.1	8.8
	12.8	2.9	6.7	1630	71.2	45.8	4.40	16.2	86.1	93.5	7.1	9.5	1.5	3.6	1800	91.2	5.84	4.6	71.4	116.9	65.0	9.0
	12.8	2.9	6.7	1850	72.4	49.3	4.56	15.9	88.0	93.8	7.3	9.8	1.6	3.8	2050	92.6	5.66	4.8	73.3	111.8	65.0	9.2
	17.0	5.2	12.1	1630	72.6	46.4	4.24	17.1	87.0	90.2	6.6	9.5	1.5	3.6	1800	91.2	5.84	4.6	71.4	116.9	65.0	9.0
90	8.5	1.2	2.8	1630	64.1	43.0	5.26	12.2	82.0	109.3	10.0	5.7	0.2	0.5	1800	91.2	5.84	4.6	71.4	116.9	65.0	9.0
	8.5	1.2	2.8	1850	65.2	46.2	5.45	12.0	83.8	109.7	10.3	5.9	0.3	0.6	2050	92.6	5.66	4.8	73.3	111.8	65.0	9.2
	12.8	2.9	6.7	1630	67.0	44.1	4.89	13.7	83.6	103.1	8.8	5.7	0.2	0.5	1800	91.2	5.84	4.6	71.4	116.9	65.0	9.0
	12.8	2.9	6.7	1850	68.1	47.4	5.07	13.4	85.4	103.4	9.0	5.9	0.3	0.6	2050	92.6	5.66	4.8	73.3	111.8	65.0	9.2
	17.0	5.2	12.0	1630	68.4	44.7	4.71	14.5	84.5	99.9	8.2	5.7	0.2	0.5	1800	91.2	5.84	4.6	71.4	116.9	65.0	9.0
100	8.5	1.2	2.8	1630	59.8	41.2	5.88	10.2	79.9	118.8	12.2	4.1	0.1	0.2	1800	91.2	5.84	4.6	71.4	116.9	65.0	9.0
	8.5	1.2	2.8	1850	60.9	44.3	6.09	10.0	81.6	119.2	12.5	4.2	0.1	0.2	2050	92.6	5.66	4.8	73.3	111.8	65.0	9.2
	12.8	2.9	6.7	1630	62.6	42.3	5.46	11.5	81.3	112.7	10.8	4.1	0.1	0.2	1800	91.2	5.84	4.6	71.4	116.9	65.0	9.0
	12.8	2.9	6.7	1850	63.7	45.5	5.66	11.2	83.0	113.0	11.0	4.2	0.1	0.2	2050	92.6	5.66	4.8	73.3	111.8	65.0	9.2
	17.0	5.2	12.0	1630	64.0	42.9	5.27	12.2	82.0	109.6	10.1	4.1	0.1	0.2	1800	91.2	5.84	4.6	71.4	116.9	65.0	9.0
110	8.5	1.1	2.6	1630	55.7	39.5	6.61	8.4	78.3	128.4	14.7	3.2	0.1	0.1	1800	91.2	5.84	4.6	71.4	116.9	65.0	9.0
	8.5	1.1	2.6	1850	56.7	42.5	6.85	8.3	80.0	128.8	15.0	3.3	0.1	0.1	2050	92.6	5.66	4.8	73.3	111.8	65.0	9.2
	12.8	2.9	6.6	1630	58.3	40.6	6.13	9.5	79.3	122.4	13.1	3.2	0.1	0.1	1800	91.2	5.84	4.6	71.4	116.9	65.0	9.0
	12.8	2.9	6.6	1850	59.3	43.6	6.36	9.3	81.0	122.7	13.4	3.3	0.1	0.1	2050	92.6	5.66	4.8	73.3	111.8	65.0	9.2
	17.0	5.1	11.8	1630	59.6	41.1	5.91	10.1	79.9	119.4	12.3	3.2	0.1	0.1	1800	91.2	5.84	4.6	71.4	116.9	65.0	9.0
120	8.5	0.9	2.1	1630	52.0	38.1	7.45	7.0	77.6	138.3	17.6	2.6	0.1	0.1	1800	91.2	5.84	4.6	71.4	116.9	65.0	9.0
	8.5	0.9	2.1	1850	52.9	41.0	7.72	6.8	79.2	138.6	18.0	2.7	0.1	0.1	2050	92.6	5.66	4.8	73.3	111.8	65.0	9.2
	12.8	2.7	6.2	1630	54.2	39.0	6.91	7.8	77.9	132.2	15.8	2.6	0.1	0.1	1800	91.2	5.84	4.6	71.4	116.9	65.0	9.0
	12.8	2.7	6.2	1850	55.2	41.9	7.16	7.7	79.6	132.5	16.1	2.7	0.1	0.1	2050	92.6	5.66	4.8	73.3	111.8	65.0	9.2
	17.0	5.0	11.5	1630	55.5	39.4	6.65	8.3	78.3	129.2	14.9	2.6	0.1	0.1	1800	91.2	5.84	4.6	71.4	116.9	65.0	9.0
17.0	5.0	11.5	1850	56.4	42.4	6.90	8.2	80.0	129.4	15.2	2.7	0.1	0.1	2050	92.6	5.66	4.8	73.3	111.8	65.0	9.2	

Interpolation is permissible; extrapolation is not. All performance is based upon the lower voltage of dual voltage rated units.

Flow is controlled to maintain minimum LWT 70° F in cooling and maximum LWT 65° F in heating.

Operation at or below 40° F EWT is based on 15% methanol antifreeze solution. Table does not reflect fan or pump power corrections for AHRI/ISO conditions.

See Performance correction tables for operating conditions other than those listed above.

For operation in the shaded areas, please see the Performance Data Selection Notes.



## Performance Data – TE H/V/D 026 (Part Load), No vFlow®

850 CFM Nominal (Rated) Airflow Heating, 750 CFM Nominal (Rated) Airflow Cooling

Performance capacities shown in thousands of Btuh

EWT °F	GPM	WPD		COOLING - EAT 80/67 °F							HEATING - 70°F						
		PSI	FT	CFM	TC	SC	kW	HR	EER	HWC	CFM	HC	kW	HE	LAT	COP	HWC
20	4.5	1.2	2.9								750	11.5	1.25	7.4	84.2	2.7	1.2
	4.5	1.2	2.9								850	11.7	1.20	7.6	82.7	2.9	1.2
30	2.3	0.5	1.1	660	23.1	14.6	0.60	25.2	38.8	0.7	750	13.0	1.23	8.9	86.0	3.1	1.3
	2.3	0.5	1.1	750	23.6	15.6	0.61	25.6	38.8	0.7	850	13.2	1.18	9.2	84.4	3.3	1.3
	3.4	0.8	1.8	660	22.8	14.0	0.55	24.7	41.1	0.7	750	13.6	1.22	9.5	86.8	3.3	1.3
	3.4	0.8	1.8	750	23.2	14.9	0.56	25.2	41.2	0.7	850	13.8	1.17	9.8	85.0	3.5	1.4
	4.5	1.1	2.6	660	22.5	13.5	0.54	24.3	41.9	0.7	750	13.9	1.22	9.9	87.2	3.4	1.4
	4.5	1.1	2.6	750	22.9	14.5	0.55	24.8	41.9	0.7	850	14.1	1.16	10.2	85.4	3.6	1.4
40	2.3	0.4	1.0	660	23.0	14.9	0.67	25.3	34.4	0.8	750	15.2	1.20	11.2	88.8	3.7	1.5
	2.3	0.4	1.0	750	23.5	16.0	0.68	25.8	34.4	0.8	850	15.4	1.15	11.5	86.8	3.9	1.5
	3.4	0.7	1.7	660	23.2	14.7	0.61	25.2	37.7	0.7	750	16.0	1.19	12.0	89.7	3.9	1.5
	3.4	0.7	1.7	750	23.6	15.8	0.63	25.7	37.7	0.7	850	16.2	1.14	12.3	87.6	4.2	1.6
	4.5	1.1	2.5	660	23.1	14.5	0.59	25.1	39.1	0.7	750	16.4	1.18	12.4	90.2	4.1	1.6
	4.5	1.1	2.5	750	23.5	15.5	0.60	25.6	39.2	0.7	850	16.6	1.13	12.8	88.1	4.3	1.6
50	2.3	0.4	1.0	660	22.4	14.9	0.76	25.0	29.6	1.1	750	17.4	1.17	13.4	91.5	4.4	1.7
	2.3	0.4	1.0	750	22.9	15.9	0.77	25.5	29.6	1.1	850	17.7	1.12	13.8	89.2	4.6	1.7
	3.4	0.7	1.6	660	22.9	15.0	0.69	25.3	33.1	0.9	750	18.3	1.16	14.4	92.6	4.6	1.7
	3.4	0.7	1.6	750	23.3	16.0	0.70	25.7	33.1	0.9	850	18.6	1.11	14.8	90.3	4.9	1.8
	4.5	1.0	2.3	660	23.1	14.9	0.66	25.3	34.9	0.8	750	18.9	1.16	14.9	93.3	4.8	1.8
	4.5	1.0	2.3	750	23.5	16.0	0.67	25.8	34.9	0.8	850	19.1	1.11	15.4	90.8	5.1	1.8
60	2.3	0.4	1.0	660	21.5	14.5	0.86	24.4	24.9	1.5	750	19.6	1.15	15.7	94.3	5.0	1.8
	2.3	0.4	1.0	750	21.9	15.5	0.88	24.9	24.9	1.5	850	19.9	1.10	16.2	91.7	5.3	1.9
	3.4	0.7	1.6	660	22.2	14.8	0.79	24.9	28.2	1.2	750	20.8	1.14	16.9	95.6	5.3	1.9
	3.4	0.7	1.6	750	22.6	15.8	0.80	25.3	28.3	1.2	850	21.1	1.09	17.3	92.9	5.6	1.9
	4.5	1.0	2.3	660	22.5	14.9	0.75	25.0	30.0	1.1	750	21.4	1.14	17.5	96.4	5.5	2.0
	4.5	1.0	2.3	750	22.9	15.9	0.76	25.5	30.0	1.1	850	21.7	1.09	18.0	93.6	5.8	2.0
70	2.3	0.4	1.0	660	20.3	14.0	0.98	23.6	20.7	2.0	750	21.9	1.14	18.0	97.1	5.7	2.0
	2.3	0.4	1.0	750	20.7	15.0	1.00	24.1	20.7	2.0	850	22.2	1.09	18.5	94.2	6.0	2.0
	3.4	0.7	1.6	660	21.1	14.4	0.90	24.2	23.6	1.6	750	23.2	1.13	19.3	98.7	6.0	2.1
	3.4	0.7	1.6	750	21.5	15.4	0.91	24.6	23.6	1.6	850	23.6	1.09	19.9	95.7	6.4	2.1
	4.5	1.0	2.2	660	21.5	14.5	0.85	24.4	25.2	1.4	750	24.0	1.13	20.1	99.6	6.2	2.2
	4.5	1.0	2.2	750	21.9	15.6	0.87	24.9	25.2	1.4	850	24.3	1.09	20.6	96.5	6.6	2.2
80	2.3	0.4	1.0	660	18.9	13.4	1.12	22.7	16.9	2.6	750	24.3	1.13	20.4	100.0	6.3	2.2
	2.3	0.4	1.0	750	19.3	14.3	1.14	23.2	16.9	2.6	850	24.6	1.09	20.9	96.8	6.6	2.2
	3.4	0.7	1.5	660	19.8	13.8	1.02	23.3	19.4	2.2	750	25.8	1.14	21.8	101.9	6.6	2.3
	3.4	0.7	1.5	750	20.2	14.8	1.04	23.8	19.4	2.2	850	26.2	1.09	22.4	98.5	7.0	2.3
	4.5	0.9	2.2	660	20.3	14.0	0.98	23.6	20.7	1.9	750	26.7	1.14	22.7	102.9	6.8	2.3
	4.5	0.9	2.2	750	20.7	15.0	1.00	24.1	20.8	2.0	850	27.1	1.10	23.3	99.5	7.2	2.3
85	2.3	0.4	1.0	660	18.2	13.0	1.2	22.3	15.3	3.0	750	25.5	1.14	21.5	101.5	6.6	2.2
	2.3	0.4	1.0	750	18.5	14.0	1.22	22.7	15.3	3.0	850	25.9	1.1	22.1	98.2	6.9	2.3
	3.4	0.7	1.5	660	19.1	13.5	1.10	22.9	17.5	2.5	750	27.1	1.1	23.1	103.5	6.9	2.3
	3.4	0.7	1.5	750	19.5	14.4	1.12	23.3	17.5	2.6	850	27.5	1.1	23.8	100.0	7.3	2.4
	4.5	0.9	2.1	660	19.6	13.7	1.05	23.2	18.8	2.3	750	28.1	1.2	24.0	104.7	7.1	2.4
	4.5	0.9	2.1	750	20.0	14.6	1.07	23.6	18.8	2.3	850	28.5	1.1	24.7	101.0	7.5	2.4
90	2.3	0.4	1.0	660	17.5	12.7	1.27	21.8	13.7	3.4	750	26.7	1.14	22.7	103.0	6.8	2.3
	2.3	0.4	1.0	750	17.8	13.6	1.30	22.2	13.7	3.4	850	27.1	1.10	23.3	99.5	7.2	2.3
	3.4	0.7	1.5	660	18.4	13.1	1.17	22.4	15.7	2.9	750	28.5	1.16	24.4	105.1	7.2	2.4
	3.4	0.7	1.5	750	18.7	14.1	1.19	22.8	15.7	2.9	850	28.9	1.11	25.1	101.4	7.6	2.4
	4.5	0.9	2.2	660	18.9	13.4	1.12	22.7	16.8	2.6	750	29.5	1.17	25.4	106.4	7.4	2.5
	4.5	0.9	2.2	750	19.2	14.3	1.14	23.1	16.9	2.7	850	29.9	1.12	26.1	102.6	7.8	2.5
100	2.3	0.4	1.0	660	16.0	12.1	1.45	21.0	11.0	4.3							
	2.3	0.4	1.0	750	16.3	13.0	1.48	21.4	11.1	4.3							
	3.4	0.7	1.5	660	16.9	12.5	1.34	21.5	12.6	3.7							
	3.4	0.7	1.5	750	17.2	13.4	1.36	21.9	12.6	3.8							
	4.5	0.9	2.1	660	17.4	12.7	1.28	21.8	13.5	3.4							
	4.5	0.9	2.1	750	17.7	13.6	1.31	22.2	13.6	3.5							
110	2.3	0.4	0.9	660	14.6	11.6	1.65	20.3	8.9	5.3							
	2.3	0.4	0.9	750	14.9	12.4	1.68	20.6	8.9	5.4							
	3.4	0.7	1.5	660	15.4	11.9	1.53	20.6	10.1	4.7							
	3.4	0.7	1.5	750	15.7	12.7	1.56	21.0	10.1	4.8							
	4.5	0.9	2.1	660	15.9	12.1	1.47	20.9	10.8	4.3							
	4.5	0.9	2.1	750	16.2	12.9	1.49	21.3	10.8	4.4							
120	2.3	0.4	0.9	660	13.4	11.3	1.87	19.8	7.2	6.5							
	2.3	0.4	0.9	750	13.7	12.1	1.91	20.2	7.2	6.6							
	3.4	0.6	1.4	660	14.1	11.5	1.74	20.0	8.1	5.8							
	3.4	0.6	1.4	750	14.4	12.3	1.77	20.4	8.1	5.9							
	4.5	0.9	2.0	660	14.5	11.6	1.67	20.2	8.6	5.4							
	4.5	0.9	2.0	750	14.7	12.4	1.71	20.6	8.6	5.5							

Interpolation is permissible, extrapolation is not. All performance data is based on the lower voltage of dual voltage units.  
 Performance stated is at the rated power supply, performance may vary as the power supply varies from the rated.  
 Table is with entering air of 80°F DB and 67°F WB in cooling, and 70°F DB in heating.  
 AHRI/ISO certified conditions are 80.6°F DB and 66.2°F WB in cooling and 68°F DB in heating.

Table does not reflect fan or pump power corrections for AHRI/ISO conditions.  
 See performance correction tables for operating conditions other than those listed above. See performance data selection notes for operation in the shaded areas.  
 Operation below 40°F EWT is based on a 15% methanol antifreeze solution.  
 Operation below 60°F EWT requires optional extended range insulated water and refrigerant circuits to avoid condensation within the unit cabinet.

Performance Data – TE H/V/D 026 (Full Load), No vFlow®

950 CFM Nominal (Rated) Airflow Heating, 850 CFM Nominal (Rated) Airflow Cooling

Performance capacities shown in thousands of Btuh

EWT °F	GPM	WPD		COOLING - EAT 80/67 °F							HEATING - 70°F						
		PSI	FT	CFM	TC	SC	kW	HR	EER	HWC	CFM	HC	kW	HE	LAT	COP	HWC
20	6.0	1.9	4.4								840	16.5	1.73	10.7	88.2	2.8	1.5
	6.0	1.9	4.4								950	16.8	1.68	11.0	86.3	2.9	1.5
30	3.0	0.7	1.6	750	30.1	18.1	0.99	33.4	30.3	0.8	840	18.2	1.70	12.6	90.1	3.1	1.7
	3.0	0.7	1.6	850	30.6	19.4	1.03	34.1	29.7	0.8	950	18.5	1.64	12.9	88.0	3.3	1.8
	4.5	1.1	2.6	750	29.8	17.6	0.93	32.8	32.1	0.7	840	19.1	1.68	13.4	91.0	3.3	1.8
	4.5	1.1	2.6	850	30.3	18.9	0.96	33.6	31.5	0.7	950	19.4	1.63	13.8	88.9	3.5	1.9
	6.0	1.8	4.0	750	29.4	17.3	0.90	32.4	32.8	0.7	840	19.5	1.68	13.9	91.5	3.4	1.9
	6.0	1.8	4.0	850	29.9	18.6	0.93	33.1	32.2	0.7	950	19.8	1.62	14.3	89.3	3.6	1.9
40	3.0	0.6	1.5	750	29.8	18.2	1.08	33.5	27.5	1.1	840	21.0	1.66	15.4	93.1	3.7	2.1
	3.0	0.6	1.5	850	30.4	19.6	1.12	34.2	27.0	1.1	950	21.3	1.61	15.8	90.8	3.9	2.1
	4.5	1.1	2.5	750	30.1	18.1	1.01	33.5	29.6	0.9	840	22.0	1.65	16.5	94.3	3.9	2.2
	4.5	1.1	2.5	850	30.6	19.5	1.05	34.2	29.1	0.9	950	22.4	1.60	16.9	91.8	4.1	2.3
	6.0	1.6	3.8	750	30.0	18.0	0.98	33.3	30.6	0.8	840	22.6	1.64	17.1	94.9	4.0	2.3
	6.0	1.6	3.8	850	30.6	19.3	1.02	34.0	30.1	0.8	950	23.0	1.59	17.5	92.4	4.2	2.3
50	3.0	0.6	1.4	750	29.1	18.0	1.19	33.1	24.5	1.5	840	23.8	1.64	18.2	96.2	4.3	2.4
	3.0	0.6	1.4	850	29.6	19.4	1.23	33.8	24.1	1.5	950	24.1	1.59	18.7	93.5	4.5	2.5
	4.5	1.0	2.3	750	29.7	18.2	1.11	33.4	26.8	1.2	840	25.1	1.64	19.5	97.6	4.5	2.6
	4.5	1.0	2.3	850	30.2	19.6	1.15	34.1	26.3	1.2	950	25.4	1.59	20.0	94.8	4.7	2.6
	6.0	1.6	3.6	750	29.9	18.2	1.07	33.5	27.9	1.1	840	25.8	1.64	20.2	98.4	4.6	2.7
	6.0	1.6	3.6	850	30.4	19.6	1.11	34.2	27.4	1.1	950	26.2	1.59	20.7	95.5	4.8	2.7
60	3.0	0.6	1.3	750	27.9	17.6	1.30	32.3	21.5	1.9	840	26.7	1.64	21.1	99.4	4.8	2.8
	3.0	0.6	1.3	850	28.4	18.9	1.35	33.0	21.1	1.9	950	27.1	1.59	21.6	96.4	5.0	2.8
	4.5	1.0	2.3	750	28.8	17.9	1.21	32.9	23.7	1.6	840	28.2	1.65	22.5	101.0	5.0	2.9
	4.5	1.0	2.3	850	29.3	19.3	1.26	33.6	23.3	1.6	950	28.6	1.60	23.1	97.9	5.2	3.0
	6.0	1.5	3.5	750	29.2	18.1	1.17	33.1	24.9	1.4	840	29.0	1.66	23.3	102.0	5.1	3.0
	6.0	1.5	3.5	850	29.7	19.4	1.22	33.8	24.4	1.4	950	29.4	1.61	24.0	98.7	5.4	3.1
70	3.0	0.6	1.3	750	26.4	17.0	1.43	31.3	18.5	2.3	840	29.6	1.67	23.9	102.6	5.2	3.1
	3.0	0.6	1.3	850	26.9	18.3	1.48	32.0	18.2	2.4	950	30.1	1.61	24.6	99.3	5.5	3.2
	4.5	1.0	2.2	750	27.5	17.5	1.33	32.0	20.6	2.1	840	31.4	1.69	25.6	104.6	5.4	3.2
	4.5	1.0	2.2	850	28.0	18.8	1.38	32.7	20.3	2.1	950	31.8	1.64	26.2	101.0	5.7	3.3
	6.0	1.5	3.4	750	28.0	17.7	1.29	32.4	21.8	1.9	840	32.3	1.71	26.5	105.7	5.5	3.3
	6.0	1.5	3.4	850	28.5	19.0	1.33	33.1	21.4	1.9	950	32.8	1.66	27.2	102.0	5.8	3.4
80	3.0	0.6	1.3	750	24.8	16.3	1.58	30.2	15.7	2.9	840	32.6	1.72	26.7	106.0	5.6	3.4
	3.0	0.6	1.3	850	25.2	17.5	1.64	30.8	15.4	3.0	950	33.1	1.66	27.5	102.3	5.8	3.5
	4.5	0.9	2.2	750	26.0	16.8	1.47	31.0	17.6	2.5	840	34.7	1.77	28.6	108.2	5.8	3.6
	4.5	0.9	2.2	850	26.4	18.1	1.53	31.6	17.3	2.6	950	35.2	1.71	29.4	104.3	6.0	3.7
	6.0	1.4	3.3	750	26.5	17.0	1.42	31.4	18.7	2.3	840	35.8	1.80	29.6	109.5	5.8	3.7
	6.0	1.4	3.3	850	27.0	18.3	1.47	32.0	18.3	2.4	950	36.3	1.74	30.4	105.4	6.1	3.8
85	3.0	0.6	1.3	750	23.9	15.9	1.7	29.6	14.4	3.3	840	34.2	1.76	28.2	107.7	5.7	3.6
	3.0	0.6	1.3	850	24.4	17.1	1.73	30.2	14.2	3.4	950	34.7	1.7	28.9	103.8	6.0	3.7
	4.5	0.9	2.2	750	25.1	16.4	1.55	30.4	16.3	2.9	840	36.4	1.8	30.1	110.1	5.9	3.8
	4.5	0.9	2.2	850	25.5	17.7	1.61	31.0	16.0	2.9	950	36.9	1.8	30.9	106.0	6.1	3.9
	6.0	1.4	3.3	750	25.7	16.7	1.50	30.8	17.2	2.7	840	37.6	1.9	31.2	111.4	5.9	3.9
	6.0	1.4	3.3	850	26.1	17.9	1.55	31.4	16.9	2.7	950	38.2	1.8	32.0	107.2	6.2	4.0
90	3.0	0.6	1.3	750	23.1	15.5	1.75	29.0	13.2	3.7	840	35.8	1.80	29.6	109.4	5.8	3.7
	3.0	0.6	1.3	850	23.5	16.7	1.81	29.7	12.9	3.7	950	36.3	1.74	30.4	105.4	6.1	3.8
	4.5	0.9	2.2	750	24.3	16.1	1.63	29.8	14.9	3.2	840	38.1	1.87	31.6	112.0	6.0	3.9
	4.5	0.9	2.2	850	24.7	17.3	1.69	30.4	14.6	3.3	950	38.7	1.81	32.5	107.7	6.2	4.0
	6.0	1.4	3.2	750	24.9	16.3	1.57	30.2	15.8	3.0	840	39.4	1.92	32.8	113.4	6.0	4.0
	6.0	1.4	3.2	850	25.3	17.5	1.63	30.9	15.5	3.0	950	40.0	1.86	33.6	109.0	6.3	4.1
100	3.0	0.6	1.3	750	21.3	14.8	1.95	28.0	10.9	4.4							
	3.0	0.6	1.3	850	21.7	15.9	2.02	28.6	10.7	4.5							
	4.5	0.9	2.1	750	22.5	15.3	1.82	28.7	12.4	3.9							
	4.5	0.9	2.1	850	22.9	16.4	1.88	29.3	12.1	4.0							
	6.0	1.4	3.2	750	23.1	15.5	1.75	29.0	13.2	3.7							
	6.0	1.4	3.2	850	23.5	16.7	1.82	29.7	12.9	3.7							
110	3.0	0.6	1.3	750	19.7	14.2	2.18	27.1	9.0	5.3							
	3.0	0.6	1.3	850	20.0	15.2	2.26	27.7	8.8	5.4							
	4.5	0.9	2.1	750	20.7	14.6	2.03	27.7	10.2	4.7							
	4.5	0.9	2.1	850	21.1	15.7	2.11	28.2	10.0	4.8							
	6.0	1.4	3.1	750	21.3	14.8	1.96	28.0	10.8	4.4							
	6.0	1.4	3.1	850	21.6	15.9	2.03	28.6	10.6	4.5							
120	3.0	0.5	1.2	750	18.2	13.7	2.46	26.6	7.4	6.2							
	3.0	0.5	1.2	850	18.5	14.7	2.55	27.2	7.3	6.4							
	4.5	0.9	2.0	750	19.1	14.0	2.28	26.9	8.3	5.6							
	4.5	0.9	2.0	850	19.4	15.0	2.37	27.5	8.2	5.8							
	6.0	1.3	3.1	750	19.5	14.1	2.20	27.1	8.9	5.3							
	6.0	1.3	3.1	850	19.9	15.2	2.28	27.7	8.7	5.5							

Interpolation is permissible, extrapolation is not. All performance data is based on the lower voltage of dual voltage units.  
 Performance stated is at the rated power supply, performance may vary as the power supply varies from the rated.  
 Table is with entering air of 80°F DB and 67°F WB in cooling, and 70°F DB in heating.  
 AHRI/ISO certified conditions are 80.6°F DB and 66.2°F WB in cooling and 68°F DB in heating.

Table does not reflect fan or pump power corrections for AHRI/ISO conditions.  
 See performance correction tables for operating conditions other than those listed above. See performance data selection notes for operation in the shaded areas.  
 Operation below 40°F EWT is based on a 15% methanol antifreeze solution.  
 Operation below 60°F EWT requires optional extended range insulated water and refrigerant circuits to avoid condensation within the unit cabinet.

## Performance Data – TE H/V/D 038 (Part Load), No vFlow®

1000 CFM Nominal (Rated) Airflow Heating, 1000 CFM Nominal (Rated) Airflow Cooling

Performance capacities shown in thousands of Btu/h

EWT °F	GPM	WPD		COOLING - EAT 80/67 °F							HEATING - 70°F						
		PSI	FT	CFM	TC	SC	kW	HR	EER	HWC	CFM	HC	kW	HE	LAT	COP	HWC
20	6.0	2.5	5.7								880	16.9	1.65	11.5	87.8	3.0	1.6
	6.0	2.5	5.7								1000	17.2	1.58	11.8	85.9	3.2	1.7
30	3.0	0.9	2.1	880	32.7	19.9	0.82	35.5	39.6	0.9	880	18.9	1.65	13.4	89.8	3.4	1.8
	3.0	0.9	2.1	1000	33.3	21.3	0.84	36.2	39.7	0.9	1000	19.1	1.58	13.7	87.7	3.5	1.8
	4.5	1.5	3.5	880	31.0	18.3	0.74	33.5	42.1	1.0	880	19.9	1.64	14.4	90.9	3.6	1.9
	4.5	1.5	3.5	1000	31.6	19.6	0.75	34.1	42.1	1.0	1000	20.2	1.57	14.8	88.7	3.8	1.9
	6.0	2.2	5.1	880	29.6	17.3	0.71	32.1	41.9	1.1	880	20.4	1.64	14.9	91.5	3.7	1.9
	6.0	2.2	5.1	1000	30.2	18.5	0.72	32.7	42.0	1.1	1000	20.7	1.57	15.4	89.2	3.9	2.0
40	3.0	0.8	1.9	880	33.1	20.7	0.94	36.4	35.2	0.9	880	21.9	1.64	16.4	93.1	3.9	2.1
	3.0	0.8	1.9	1000	33.8	22.2	0.96	37.1	35.2	0.9	1000	22.2	1.57	16.9	90.6	4.2	2.1
	4.5	1.4	3.2	880	32.9	20.1	0.84	35.8	39.0	0.8	880	23.1	1.64	17.6	94.3	4.1	2.2
	4.5	1.4	3.2	1000	33.6	21.5	0.86	36.5	39.0	0.8	1000	23.5	1.57	18.1	91.7	4.4	2.2
	6.0	2.0	4.7	880	32.4	19.6	0.80	35.1	40.7	0.8	880	23.8	1.64	18.3	95.1	4.3	2.2
	6.0	2.0	4.7	1000	33.0	20.9	0.81	35.8	40.8	0.9	1000	24.1	1.57	18.8	92.4	4.5	2.3
50	3.0	0.8	1.8	880	32.3	20.7	1.08	36.0	29.9	1.1	880	24.9	1.64	19.4	96.2	4.5	2.3
	3.0	0.8	1.8	1000	33.0	22.2	1.10	36.7	30.0	1.1	1000	25.3	1.57	19.9	93.4	4.7	2.4
	4.5	1.3	3.0	880	33.1	20.7	0.96	36.4	34.4	0.9	880	26.3	1.64	20.7	97.7	4.7	2.5
	4.5	1.3	3.0	1000	33.7	22.2	0.98	37.1	34.4	0.9	1000	26.7	1.57	21.3	94.7	5.0	2.5
	6.0	1.9	4.4	880	33.2	20.6	0.91	36.3	36.3	0.9	880	27.1	1.64	21.5	98.5	4.8	2.5
	6.0	1.9	4.4	1000	33.8	22.0	0.93	37.0	36.4	0.9	1000	27.5	1.57	22.1	95.4	5.1	2.6
60	3.0	0.8	1.8	880	30.8	20.2	1.24	35.0	24.9	1.5	880	27.9	1.65	22.3	99.3	5.0	2.6
	3.0	0.8	1.8	1000	31.4	21.6	1.26	35.7	24.9	1.5	1000	28.3	1.58	22.9	96.2	5.2	2.6
	4.5	1.3	2.9	880	32.1	20.6	1.11	35.9	28.9	1.2	880	29.5	1.65	23.8	101.0	5.2	2.7
	4.5	1.3	2.9	1000	32.7	22.1	1.13	36.6	29.0	1.3	1000	29.9	1.58	24.5	97.7	5.5	2.8
	6.0	1.8	4.2	880	32.6	20.8	1.05	36.2	31.0	1.1	880	30.4	1.65	24.7	102.0	5.4	2.8
	6.0	1.8	4.2	1000	33.2	22.2	1.07	36.9	31.1	1.2	1000	30.8	1.58	25.4	98.5	5.7	2.8
70	3.0	1.2	2.7	880	28.8	19.4	1.41	33.6	20.4	2.1	880	30.8	1.66	25.2	102.4	5.4	2.8
	3.0	1.2	2.7	1000	29.4	20.7	1.44	34.3	20.4	2.2	1000	31.3	1.59	25.9	99.0	5.8	2.9
	4.5	1.9	4.4	880	30.4	20.0	1.28	34.7	23.8	1.8	880	32.7	1.67	27.0	104.4	5.7	2.9
	4.5	1.9	4.4	1000	31.0	21.4	1.30	35.4	23.8	1.8	1000	33.2	1.60	27.7	100.7	6.1	3.0
	6.0	2.9	6.6	880	31.1	20.3	1.21	35.2	25.8	1.6	880	33.7	1.67	28.0	105.5	5.9	3.0
	6.0	2.9	6.6	1000	31.7	21.7	1.23	35.9	25.8	1.6	1000	34.2	1.60	28.7	101.7	6.3	3.1
80	3.0	1.2	2.7	880	26.6	18.4	1.61	32.1	16.5	3.0	880	33.9	1.67	28.1	105.6	5.9	3.0
	3.0	1.2	2.7	1000	27.1	19.7	1.64	32.7	16.5	3.0	1000	34.3	1.60	28.9	101.8	6.3	3.1
	4.5	1.9	4.3	880	28.3	19.1	1.46	33.2	19.3	2.5	880	36.0	1.69	30.2	107.9	6.2	3.2
	4.5	1.9	4.3	1000	28.8	20.5	1.49	33.9	19.3	2.6	1000	36.5	1.62	31.0	103.8	6.6	3.2
	6.0	2.8	6.5	880	29.1	19.5	1.38	33.8	21.0	2.3	880	37.2	1.70	31.3	109.2	6.4	3.3
	6.0	2.8	6.5	1000	29.7	20.9	1.41	34.5	21.0	2.3	1000	37.8	1.63	32.2	105.0	6.8	3.3
85	3.0	1.2	2.7	880	25.5	17.9	1.7	31.4	14.9	3.5	880	35.4	1.68	29.6	107.3	6.2	3.1
	3.0	1.2	2.7	1000	26.0	19.2	1.76	32.0	14.9	3.6	1000	35.9	1.6	30.4	103.3	6.5	3.2
	4.5	1.9	4.3	880	27.1	18.6	1.57	32.4	17.4	3.0	880	37.8	1.7	31.8	109.7	6.5	3.3
	4.5	1.9	4.3	1000	27.6	19.9	1.60	33.1	17.5	3.0	1000	38.3	1.6	32.7	105.5	6.9	3.4
	6.0	2.8	6.4	880	28.0	19.0	1.49	33.0	18.9	2.7	880	39.1	1.7	33.1	111.1	6.7	3.4
	6.0	2.8	6.4	1000	28.5	20.3	1.52	33.7	19.0	2.8	1000	39.7	1.7	34.0	106.7	7.0	3.4
90	3.0	1.2	2.7	880	24.4	17.4	1.84	30.7	13.3	4.0	880	37.0	1.70	31.1	108.9	6.4	3.3
	3.0	1.2	2.7	1000	24.9	18.7	1.87	31.3	13.3	4.1	1000	37.5	1.63	32.0	104.7	6.7	3.3
	4.5	1.9	4.3	880	26.0	18.1	1.67	31.7	15.6	3.4	880	39.5	1.72	33.5	111.6	6.7	3.4
	4.5	1.9	4.3	1000	26.5	19.4	1.70	32.3	15.6	3.5	1000	40.1	1.65	34.4	107.1	7.1	3.5
	6.0	2.8	6.3	880	26.8	18.5	1.59	32.2	16.9	3.2	880	41.0	1.74	34.9	113.1	6.9	3.5
	6.0	2.8	6.3	1000	27.3	19.8	1.62	32.9	16.9	3.2	1000	41.5	1.67	35.8	108.5	7.3	3.6
100	3.0	1.2	2.7	880	22.5	16.6	2.09	29.6	10.7	5.2							
	3.0	1.2	2.7	1000	22.9	17.8	2.13	30.1	10.7	5.3							
	4.5	1.8	4.2	880	23.8	17.1	1.91	30.3	12.5	4.6							
	4.5	1.8	4.2	1000	24.2	18.4	1.94	30.9	12.5	4.7							
	6.0	2.7	6.3	880	24.5	17.5	1.83	30.7	13.4	4.3							
	6.0	2.7	6.3	1000	25.0	18.7	1.86	31.3	13.4	4.4							
110	3.0	1.1	2.6	880	21.0	16.3	2.39	29.1	8.8	6.7							
	3.0	1.1	2.6	1000	21.4	17.4	2.43	29.7	8.8	6.8							
	4.5	1.8	4.2	880	21.9	16.4	2.19	29.3	10.0	5.9							
	4.5	1.8	4.2	1000	22.3	17.6	2.23	29.9	10.0	6.1							
	6.0	2.7	6.2	880	22.5	16.6	2.09	29.6	10.7	5.6							
	6.0	2.7	6.2	1000	22.9	17.8	2.13	30.2	10.7	5.7							
120	3.0	1.1	2.5	880	20.4	16.8	2.75	29.8	7.4	8.4							
	3.0	1.1	2.5	1000	20.8	17.9	2.80	30.4	7.4	8.6							
	4.5	1.7	4.0	880	20.7	16.3	2.50	29.2	8.3	7.6							
	4.5	1.7	4.0	1000	21.1	17.5	2.55	29.8	8.3	7.7							
	6.0	2.6	6.0	880	21.0	16.3	2.40	29.1	8.8	7.2							
	6.0	2.6	6.0	1000	21.4	17.4	2.44	29.7	8.8	7.3							

Interpolation is permissible, extrapolation is not. All performance data is based on the lower voltage of dual voltage units. Performance stated is at the rated power supply, performance may vary as the power supply varies from the rated. Table is with entering air of 80°F DB and 67°F WB in cooling, and 70°F DB in heating. AHRI/ISO certified conditions are 80.6°F DB and 66.2°F WB in cooling and 68°F DB in heating. Table does not reflect fan or pump power corrections for AHRI/ISO conditions.

See performance correction tables for operating conditions other than those listed above. See performance data selection notes for operation in the shaded areas. Operation below 40°F EWT is based on a 15% methanol antifreeze solution. Operation below 60°F EWT requires optional extended range insulated water and refrigerant circuits to avoid condensation within the unit cabinet.

# Performance Data – TE H/V/D 038 (Full Load), No vFlow®

1250 CFM Nominal (Rated) Airflow Heating, 1250 CFM Nominal (Rated) Airflow Cooling

Performance capacities shown in thousands of Btuh

EWT °F	GPM	WPD		COOLING - EAT 80/67 °F							HEATING - 70°F						
		PSI	FT	CFM	TC	SC	kW	HR	EER	HWC	CFM	HC	kW	HE	LAT	COP	HWC
20	9.0	4.3	9.9								1100	25.2	2.23	17.8	91.2	3.3	2.0
	9.0	4.3	9.9								1250	25.6	2.16	18.2	89.0	3.5	2.1
30	4.5	1.5	3.5	1100	45.4	26.4	1.46	50.2	31.0	1.1	1100	27.7	2.25	20.1	93.3	3.6	2.3
	4.5	1.5	3.5	1250	46.1	28.4	1.52	51.3	30.4	1.1	1250	28.1	2.18	20.7	90.8	3.8	2.4
	6.8	2.6	6.0	1100	45.1	25.9	1.36	49.6	33.2	0.9	1100	29.0	2.26	21.4	94.4	3.8	2.5
	6.8	2.6	6.0	1250	45.9	27.8	1.41	50.7	32.6	0.9	1250	29.5	2.19	22.0	91.8	3.9	2.5
	9.0	3.9	9.1	1100	44.8	25.5	1.31	49.2	34.2	0.8	1100	29.7	2.26	22.1	95.0	3.9	2.6
	9.0	3.9	9.1	1250	45.6	27.4	1.36	50.2	33.6	0.8	1250	30.2	2.19	22.7	92.4	4.0	2.6
40	4.5	1.4	3.2	1100	44.9	26.7	1.60	50.3	28.1	1.4	1100	31.8	2.29	24.0	96.7	4.1	2.8
	4.5	1.4	3.2	1250	45.7	28.7	1.66	51.4	27.6	1.5	1250	32.2	2.21	24.7	93.9	4.3	2.9
	6.8	2.4	5.5	1100	45.3	26.5	1.50	50.3	30.3	1.1	1100	33.3	2.30	25.5	98.1	4.2	3.0
	6.8	2.4	5.5	1250	46.1	28.5	1.55	51.4	29.8	1.2	1250	33.8	2.23	26.2	95.1	4.4	3.1
	9.0	3.6	8.4	1100	45.4	26.3	1.44	50.2	31.4	1.0	1100	34.2	2.31	26.3	98.8	4.3	3.1
	9.0	3.6	8.4	1250	46.1	28.3	1.50	51.2	30.8	1.0	1250	34.7	2.24	27.1	95.7	4.5	3.2
50	4.5	1.3	3.0	1100	43.9	26.6	1.74	49.7	25.2	2.0	1100	35.8	2.34	27.9	100.1	4.5	3.3
	4.5	1.3	3.0	1250	44.6	28.6	1.80	50.8	24.7	2.0	1250	36.3	2.26	28.6	96.9	4.7	3.4
	6.8	2.2	5.1	1100	44.7	26.7	1.63	50.2	27.4	1.5	1100	37.6	2.36	29.6	101.6	4.7	3.5
	6.8	2.2	5.1	1250	45.5	28.7	1.69	51.3	26.9	1.6	1250	38.2	2.29	30.3	98.3	4.9	3.6
	9.0	3.4	7.9	1100	45.0	26.7	1.58	50.3	28.5	1.4	1100	38.6	2.38	30.5	102.5	4.8	3.6
	9.0	3.4	7.9	1250	45.8	28.7	1.64	51.4	28.0	1.4	1250	39.2	2.31	31.3	99.0	5.0	3.7
60	4.5	1.3	2.9	1100	42.3	26.1	1.90	48.7	22.3	2.6	1100	39.8	2.40	31.6	103.5	4.9	3.7
	4.5	1.3	2.9	1250	43.0	28.1	1.97	49.8	21.9	2.7	1250	40.4	2.33	32.5	99.9	5.1	3.8
	6.8	2.1	4.9	1100	43.5	26.5	1.78	49.5	24.5	2.1	1100	41.9	2.44	33.5	105.2	5.0	4.0
	6.8	2.1	4.9	1250	44.3	28.5	1.84	50.6	24.0	2.2	1250	42.5	2.37	34.4	101.5	5.3	4.1
	9.0	3.3	7.5	1100	44.0	26.6	1.72	49.8	25.6	1.9	1100	43.0	2.47	34.6	106.2	5.1	4.1
	9.0	3.3	7.5	1250	44.8	28.6	1.78	50.9	25.1	1.9	1250	43.7	2.39	35.5	102.3	5.4	4.2
70	4.5	1.2	2.9	1100	40.4	25.4	2.08	47.4	19.4	3.4	1100	43.9	2.49	35.4	106.9	5.2	4.2
	4.5	1.2	2.9	1250	41.1	27.4	2.15	48.4	19.1	3.5	1250	44.5	2.41	36.3	103.0	5.4	4.3
	6.8	2.1	4.8	1100	41.8	26.0	1.94	48.4	21.5	2.8	1100	46.2	2.54	37.5	108.9	5.3	4.5
	6.8	2.1	4.8	1250	42.6	27.9	2.02	49.4	21.1	2.9	1250	46.9	2.47	38.5	104.8	5.6	4.6
	9.0	3.1	7.2	1100	42.5	26.2	1.88	48.8	22.6	2.5	1100	47.6	2.58	38.7	110.0	5.4	4.6
	9.0	3.1	7.2	1250	43.2	28.2	1.95	49.9	22.2	2.6	1250	48.3	2.50	39.7	105.8	5.7	4.7
80	4.5	1.2	2.9	1100	38.2	24.6	2.29	45.9	16.7	4.3	1100	48.0	2.59	39.2	110.4	5.4	4.6
	4.5	1.2	2.9	1250	38.8	26.4	2.37	46.9	16.4	4.4	1250	48.8	2.51	40.2	106.1	5.7	4.7
	6.8	2.0	4.7	1100	39.8	25.2	2.14	47.0	18.6	3.6	1100	50.8	2.67	41.6	112.7	5.6	4.9
	6.8	2.0	4.7	1250	40.5	27.1	2.21	48.0	18.3	3.7	1250	51.5	2.59	42.7	108.2	5.8	5.0
	9.0	3.1	7.1	1100	40.5	25.5	2.06	47.5	19.6	3.9	1100	52.3	2.72	42.9	114.0	5.6	5.1
	9.0	3.1	7.1	1250	41.2	27.4	2.14	48.5	19.3	4.0	1250	53.1	2.64	44.1	109.3	5.9	5.2
85	4.5	1.2	2.9	1100	37.0	24.1	2.4	45.2	15.4	4.8	1100	50.2	2.66	41.1	112.3	5.5	4.8
	4.5	1.2	2.9	1250	37.6	25.9	2.50	46.2	15.1	4.9	1250	51.0	2.6	42.2	107.8	5.8	5.0
	6.8	2.0	4.6	1100	38.6	24.7	2.25	46.2	17.2	4.1	1100	53.1	2.8	43.7	114.7	5.7	5.1
	6.8	2.0	4.6	1250	39.3	26.6	2.33	47.2	16.9	4.2	1250	53.9	2.7	44.8	110.0	5.9	5.3
	9.0	3.0	7.0	1100	39.4	25.1	2.17	46.8	18.2	4.1	1100	54.8	2.8	45.1	116.1	5.7	5.3
	9.0	3.0	7.0	1250	40.1	27.0	2.25	47.8	17.9	4.2	1250	55.6	2.7	46.3	111.2	6.0	5.4
90	4.5	1.2	2.9	1100	35.8	23.6	2.54	44.4	14.1	5.3	1100	52.4	2.73	43.0	114.1	5.6	5.1
	4.5	1.2	2.9	1250	36.4	25.4	2.63	45.4	13.9	5.5	1250	53.2	2.64	44.2	109.4	5.9	5.2
	6.8	2.0	4.6	1100	37.4	24.3	2.36	45.5	15.9	4.6	1100	55.5	2.84	45.7	116.7	5.7	5.4
	6.8	2.0	4.6	1250	38.1	26.1	2.45	46.4	15.6	4.7	1250	56.3	2.75	47.0	111.7	6.0	5.5
	9.0	3.0	6.9	1100	38.3	24.6	2.28	46.0	16.8	4.3	1100	57.3	2.90	47.3	118.2	5.8	5.5
	9.0	3.0	6.9	1250	38.9	26.5	2.36	47.0	16.5	4.3	1250	58.1	2.81	48.5	113.1	6.1	5.6
100	4.5	1.2	2.8	1100	33.3	22.5	2.83	43.0	11.8	6.5							
	4.5	1.2	2.8	1250	33.9	24.2	2.93	43.9	11.6	6.7							
	6.8	2.0	4.5	1100	35.0	23.2	2.63	43.9	13.3	5.7							
	6.8	2.0	4.5	1250	35.6	25.0	2.72	44.9	13.1	5.9							
	9.0	3.0	6.8	1100	35.8	23.6	2.53	44.4	14.1	5.3							
	9.0	3.0	6.8	1250	36.4	25.4	2.63	45.4	13.9	5.5							
110	4.5	1.2	2.8	1100	30.9	21.4	3.18	41.7	9.7	7.9							
	4.5	1.2	2.8	1250	31.4	23.0	3.29	42.6	9.5	8.0							
	6.8	1.9	4.5	1100	32.4	22.1	2.95	42.5	11.0	7.0							
	6.8	1.9	4.5	1250	33.0	23.8	3.05	43.4	10.8	7.1							
	9.0	2.9	6.7	1100	33.3	22.5	2.84	42.9	11.7	6.6							
	9.0	2.9	6.7	1250	33.8	24.2	2.94	43.9	11.5	6.7							
120	4.5	1.1	2.6	1100	28.5	20.3	3.59	40.8	7.9	9.4							
	4.5	1.1	2.6	1250	29.0	21.9	3.72	41.7	7.8	9.6							
	6.8	1.9	4.3	1100	29.9	21.0	3.32	41.3	9.0	8.4							
	6.8	1.9	4.3	1250	30.5	22.6	3.44	42.2	8.8	8.6							
	9.0	2.9	6.6	1100	30.7	21.3	3.20	41.7	9.6	8.0							
	9.0	2.9	6.6	1250	31.3	23.0	3.31	42.6	9.4	8.1							

Interpolation is permissible, extrapolation is not. All performance data is based on the lower voltage of dual voltage units.  
 Performance stated is at the rated power supply, performance may vary as the power supply varies from the rated.  
 Table is with entering air of 80°F DB and 67°F WB in cooling, and 70°F DB in heating.  
 AHRI/ISO certified conditions are 80.6°F DB and 66.2°F WB in cooling and 68°F DB in heating.  
 Table does not reflect fan or pump power corrections for AHRI/ISO conditions.  
 See performance correction tables for operating conditions other than those listed above. See

performance data selection notes for operation in the shaded areas.  
 Operation below 40°F EWT is based on a 15% methanol antifreeze solution.  
 Operation below 60°F EWT requires optional extended range insulated water and refrigerant circuits to avoid condensation within the unit cabinet.

## Performance Data – TE H/V/D 049 (Part Load), No vFlow<sup>®</sup>

1350 CFM Nominal (Rated) Airflow Heating, 1350 CFM Nominal (Rated) Airflow Cooling

Performance capacities shown in thousands of Btuh

EWT °F	GPM	WPD		COOLING - EAT 80/67 °F							HEATING - 70°F						
		PSI	FT	CFM	TC	SC	kW	HR	EER	HWC	CFM	HC	kW	HE	LAT	COP	HWC
20	9.0	2.3	5.4								1190	22.8	2.37	14.9	87.7	2.8	2.5
	9.0	2.3	5.4								1350	23.1	2.28	15.3	85.8	3.0	2.5
30	4.5	0.2	0.6	1190	40.9	25.0	1.11	44.7	37.0	1.0	1190	25.0	2.35	17.2	89.4	3.1	2.5
	4.5	0.2	0.6	1350	41.7	26.7	1.13	45.6	37.0	1.0	1350	25.3	2.25	17.6	87.4	3.3	2.6
	6.8	1.2	2.8	1190	39.5	22.6	1.02	43.0	38.6	1.0	1190	25.9	2.34	18.1	90.2	3.2	2.5
	6.8	1.2	2.8	1350	40.3	24.2	1.04	43.8	38.6	1.1	1350	26.3	2.24	18.6	88.0	3.4	2.6
	9.0	2.1	4.9	1190	38.5	21.2	0.99	41.9	38.9	1.1	1190	26.5	2.33	18.7	90.6	3.3	2.6
	9.0	2.1	4.9	1350	39.3	22.7	1.01	42.7	38.9	1.1	1350	26.8	2.24	19.2	88.4	3.5	2.6
40	4.5	0.2	0.4	1190	41.7	27.1	1.26	46.0	33.1	1.1	1190	28.5	2.32	20.8	92.2	3.6	2.6
	4.5	0.2	0.4	1350	42.5	29.1	1.28	46.9	33.1	1.2	1350	28.9	2.23	21.3	89.8	3.8	2.7
	6.8	1.1	2.5	1190	41.3	25.8	1.15	45.3	35.9	1.0	1190	29.8	2.32	22.0	93.2	3.8	2.7
	6.8	1.1	2.5	1350	42.1	27.6	1.17	46.2	35.9	1.0	1350	30.2	2.23	22.6	90.7	4.0	2.7
	9.0	2.0	4.6	1190	40.9	24.9	1.11	44.7	37.0	1.0	1190	30.5	2.32	22.7	93.7	3.9	2.7
	9.0	2.0	4.6	1350	41.7	26.7	1.13	45.6	37.0	1.0	1350	30.9	2.22	23.3	91.2	4.1	2.7
50	4.5	0.1	0.3	1190	41.2	28.0	1.45	46.1	28.5	1.5	1190	32.3	2.32	24.5	95.2	4.1	2.7
	4.5	0.1	0.3	1350	42.0	30.0	1.47	47.0	28.6	1.5	1350	32.8	2.22	25.2	92.5	4.3	2.8
	6.8	1.0	2.3	1190	41.7	27.5	1.31	46.1	31.7	1.2	1190	33.9	2.32	26.1	96.4	4.3	2.8
	6.8	1.0	2.3	1350	42.5	29.5	1.34	47.0	31.7	1.2	1350	34.4	2.23	26.8	93.6	4.5	2.9
	9.0	1.9	4.3	1190	41.7	27.1	1.25	46.0	33.2	1.1	1190	34.8	2.32	26.9	97.1	4.4	2.8
	9.0	1.9	4.3	1350	42.5	29.0	1.28	46.9	33.3	1.1	1350	35.3	2.23	27.7	94.2	4.6	2.9
60	4.5	0.1	0.2	1190	39.8	27.8	1.66	45.5	24.0	2.0	1190	36.3	2.33	28.4	98.3	4.6	2.9
	4.5	0.1	0.2	1350	40.6	29.8	1.69	46.4	24.1	2.1	1350	36.8	2.23	29.2	95.3	4.8	3.0
	6.8	1.0	2.2	1190	40.9	28.0	1.51	46.0	27.1	1.6	1190	38.2	2.34	30.3	99.7	4.8	3.0
	6.8	1.0	2.2	1350	41.7	30.0	1.53	46.9	27.2	1.7	1350	38.7	2.24	31.1	96.6	5.1	3.1
	9.0	1.8	4.2	1190	41.3	28.0	1.44	46.2	28.7	1.5	1190	39.2	2.34	31.3	100.5	4.9	3.0
	9.0	1.8	4.2	1350	42.1	29.9	1.46	47.0	28.8	1.5	1350	39.8	2.25	32.1	97.3	5.2	3.1
70	4.5	0.1	0.2	1190	37.9	27.1	1.90	44.4	19.9	2.5	1190	40.4	2.35	32.4	101.4	5.0	3.1
	4.5	0.1	0.2	1350	38.6	29.0	1.94	45.2	19.9	2.5	1350	41.0	2.25	33.3	98.1	5.3	3.2
	6.8	0.9	2.1	1190	39.3	27.7	1.73	45.2	22.7	2.1	1190	42.6	2.36	34.5	103.1	5.3	3.2
	6.8	0.9	2.1	1350	40.0	29.6	1.76	46.1	22.7	2.1	1350	43.2	2.26	35.5	99.6	5.6	3.3
	9.0	1.8	4.0	1190	39.9	27.9	1.65	45.5	24.2	1.9	1190	43.8	2.37	35.7	104.1	5.4	3.3
	9.0	1.8	4.0	1350	40.7	29.8	1.68	46.4	24.2	1.9	1350	44.4	2.27	36.7	100.5	5.7	3.4
80	4.5	0.1	0.3	1190	35.5	26.0	2.18	42.9	16.3	3.3	1190	44.6	2.37	36.4	104.7	5.5	3.3
	4.5	0.1	0.3	1350	36.2	27.8	2.22	43.7	16.3	3.4	1350	45.2	2.27	37.4	101.0	5.8	3.4
	6.8	0.9	2.1	1190	37.1	26.7	1.99	43.9	18.6	2.8	1190	47.0	2.38	38.8	106.6	5.8	3.5
	6.8	0.9	2.1	1350	37.8	28.6	2.03	44.7	18.6	2.9	1350	47.7	2.29	39.9	102.7	6.1	3.6
	9.0	1.7	4.0	1190	37.9	27.1	1.90	44.4	19.9	2.6	1190	48.3	2.39	40.1	107.6	5.9	3.8
	9.0	1.7	4.0	1350	38.6	29.0	1.94	45.2	19.9	2.7	1350	49.0	2.29	41.2	103.6	6.3	3.9
85	4.5	0.1	0.3	1190	34.2	25.4	2.3	42.1	14.7	3.8	1190	46.6	2.38	38.4	106.3	5.7	3.5
	4.5	0.1	0.3	1350	34.8	27.1	2.38	43.0	14.8	3.9	1350	47.3	2.3	39.5	102.4	6.1	3.5
	6.8	0.9	2.1	1190	35.8	26.1	2.14	43.1	16.9	3.3	1190	49.2	2.4	40.9	108.3	6.0	3.7
	6.8	0.9	2.1	1350	36.5	28.0	2.18	44.0	16.9	3.4	1350	49.9	2.3	42.0	104.2	6.4	3.7
	9.0	1.7	4.0	1190	36.6	26.5	2.04	43.6	18.1	3.1	1190	50.6	2.4	42.3	109.4	6.2	3.9
	9.0	1.7	4.0	1350	37.4	28.4	2.08	44.5	18.1	3.1	1350	51.3	2.3	43.4	105.2	6.5	3.9
90	4.5	0.1	0.3	1190	32.9	24.7	2.49	41.4	13.2	4.4	1190	48.7	2.39	40.4	107.9	6.0	3.6
	4.5	0.1	0.3	1350	33.5	26.5	2.54	42.2	13.2	4.4	1350	49.4	2.30	41.5	103.9	6.3	3.7
	6.8	0.9	2.1	1190	34.6	25.5	2.29	42.4	15.1	3.8	1190	51.4	2.41	43.0	110.0	6.3	3.8
	6.8	0.9	2.1	1350	35.2	27.3	2.33	43.2	15.1	3.9	1350	52.1	2.31	44.2	105.7	6.6	3.9
	9.0	1.7	3.9	1190	35.4	25.9	2.19	42.9	16.2	3.5	1190	52.8	2.41	44.4	111.1	6.4	3.9
	9.0	1.7	3.9	1350	36.1	27.8	2.23	43.7	16.2	3.6	1350	53.6	2.31	45.7	106.7	6.8	4.0
100	4.5	0.1	0.3	1190	30.2	23.5	2.84	39.9	10.6	5.6							
	4.5	0.1	0.3	1350	30.8	25.2	2.89	40.7	10.6	5.7							
	6.8	0.9	2.1	1190	31.9	24.3	2.62	40.8	12.2	5.0							
	6.8	0.9	2.1	1350	32.5	26.0	2.67	41.6	12.2	5.1							
	9.0	1.7	3.8	1190	32.7	24.6	2.51	41.3	13.0	4.7							
	9.0	1.7	3.8	1350	33.3	26.4	2.56	42.1	13.0	4.7							
110	4.5	0.1	0.2	1190	27.7	22.6	3.24	38.7	8.5	7.1							
	4.5	0.1	0.2	1350	28.2	24.2	3.30	39.5	8.6	7.2							
	6.8	0.9	2.0	1190	29.2	23.1	3.00	39.4	9.7	6.3							
	6.8	0.9	2.0	1350	29.7	24.7	3.05	40.1	9.7	6.5							
	9.0	1.6	3.7	1190	30.0	23.4	2.88	39.8	10.4	6.0							
	9.0	1.6	3.7	1350	30.5	25.1	2.93	40.5	10.4	6.1							
120	4.5	0.1	0.1	1190	25.4	22.0	3.69	38.0	6.9	8.7							
	4.5	0.1	0.1	1350	25.9	23.6	3.75	38.7	6.9	8.9							
	6.8	0.8	1.9	1190	26.7	22.3	3.42	38.3	7.8	7.9							
	6.8	0.8	1.9	1350	27.2	23.9	3.48	39.1	7.8	8.1							
	9.0	1.6	3.6	1190	27.4	22.5	3.29	38.6	8.3	7.5							
	9.0	1.6	3.6	1350	27.9	24.1	3.35	39.3	8.3	7.7							

Interpolation is permissible, extrapolation is not. All performance data is based on the lower voltage of dual voltage units.  
 Performance stated is at the rated power supply, performance may vary as the power supply varies from the rated.  
 Table is with entering air of 80°F DB and 67°F WB in cooling, and 70°F DB in heating.  
 AHRI/ISO certified conditions are 80.6°F DB and 66.2°F WB in cooling and 68°F DB in heating.

Table does not reflect fan or pump power corrections for AHRI/ISO conditions.  
 See performance correction tables for operating conditions other than those listed above. See performance data selection notes for operation in the shaded areas.  
 Operation below 40°F EWT is based on a 15% methanol antifreeze solution.  
 Operation below 60°F EWT requires optional extended range insulated water and refrigerant circuits to avoid condensation within the unit cabinet.



Performance Data – TE H/V/D 049 (Full Load), No vFlow®

1650 CFM Nominal (Rated) Airflow Heating, 1550 CFM Nominal (Rated) Airflow Cooling

Performance capacities shown in thousands of Btuh

EWT °F	GPM	WPD		COOLING - EAT 80/67 °F							HEATING - 70°F						
		PSI	FT	CFM	TC	SC	kW	HR	EER	HWC	CFM	HC	kW	HE	LAT	COP	HWC
20	12.0	4.1	9.4								1450	31.4	3.17	20.9	90.1	2.9	3.3
	12.0	4.1	9.4								1650	31.9	3.07	21.4	87.9	3.0	3.3
30	6.0	0.9	2.1	1364	48.8	27.0	1.80	54.8	27.0	1.8	1450	34.7	3.16	24.2	92.2	3.2	3.4
	6.0	0.9	2.1	1550	49.6	29.1	1.87	56.0	26.6	1.8	1650	35.3	3.06	24.8	89.8	3.4	3.5
	9.0	2.1	4.9	1364	44.1	23.2	1.64	49.7	26.8	1.8	1450	36.2	3.16	25.7	93.1	3.4	3.5
	9.0	2.1	4.9	1550	44.9	25.0	1.70	50.7	26.3	1.9	1650	36.8	3.06	26.3	90.6	3.5	3.5
	12.0	3.8	8.8	1364	41.5	21.3	1.57	46.8	26.4	1.9	1450	37.1	3.16	26.5	93.7	3.4	3.5
	12.0	3.8	8.8	1550	42.2	22.9	1.63	47.8	25.9	1.9	1650	37.6	3.06	27.2	91.1	3.6	3.6
40	6.0	0.8	1.8	1364	53.0	31.2	2.05	59.8	25.8	1.9	1450	39.9	3.18	29.2	95.5	3.7	3.6
	6.0	0.8	1.8	1550	53.9	33.6	2.12	61.1	25.4	2.0	1650	40.5	3.08	30.0	92.7	3.8	3.7
	9.0	2.0	4.6	1364	50.7	28.8	1.89	57.1	26.8	1.8	1450	41.7	3.20	30.9	96.6	3.8	3.7
	9.0	2.0	4.6	1550	51.6	31.0	1.96	58.3	26.3	1.8	1650	42.3	3.11	31.7	93.8	4.0	3.8
	12.0	3.6	8.4	1364	49.1	27.4	1.82	55.2	27.0	1.8	1450	42.7	3.22	31.8	97.3	3.9	3.8
	12.0	3.6	8.4	1550	50.0	29.4	1.88	56.4	26.5	1.8	1650	43.3	3.12	32.7	94.3	4.1	3.9
50	6.0	0.7	1.7	1364	54.0	33.2	2.28	61.7	23.7	2.3	1450	45.0	3.26	34.0	98.8	4.0	3.9
	6.0	0.7	1.7	1550	54.9	35.7	2.37	63.0	23.2	2.3	1650	45.7	3.16	34.9	95.7	4.2	4.0
	9.0	1.9	4.3	1364	53.5	32.0	2.12	60.7	25.2	2.0	1450	47.2	3.30	36.0	100.1	4.2	4.1
	9.0	1.9	4.3	1550	54.5	34.5	2.20	62.0	24.8	2.1	1650	47.9	3.20	37.0	96.9	4.4	4.1
	12.0	3.5	8.0	1364	52.9	31.2	2.05	59.8	25.9	1.9	1450	48.3	3.33	37.1	100.9	4.3	4.1
	12.0	3.5	8.0	1550	53.8	33.5	2.12	61.1	25.4	2.0	1650	49.1	3.23	38.1	97.5	4.5	4.2
60	6.0	0.7	1.6	1364	53.1	33.6	2.52	61.6	21.1	2.9	1450	50.2	3.38	38.8	102.1	4.4	4.3
	6.0	0.7	1.6	1550	54.0	36.1	2.61	62.9	20.7	2.9	1650	51.0	3.27	39.8	98.6	4.6	4.4
	9.0	1.8	4.2	1364	53.9	33.4	2.35	61.8	22.9	2.4	1450	52.7	3.44	41.0	103.6	4.5	4.4
	9.0	1.8	4.2	1550	54.8	36.0	2.44	63.1	22.5	2.5	1650	53.5	3.33	42.1	100.0	4.7	4.5
	12.0	3.4	7.8	1364	54.0	33.1	2.27	61.6	23.8	2.3	1450	54.0	3.48	42.2	104.5	4.6	4.5
	12.0	3.4	7.8	1550	54.9	35.6	2.35	63.0	23.3	2.3	1650	54.8	3.37	43.3	100.8	4.8	4.6
70	6.0	0.7	1.5	1364	51.0	33.0	2.78	60.4	18.4	3.6	1450	55.5	3.52	43.5	105.4	4.6	4.6
	6.0	0.7	1.5	1550	51.9	35.5	2.88	61.7	18.0	3.7	1650	56.3	3.41	44.7	101.6	4.8	4.7
	9.0	1.8	4.0	1364	52.6	33.5	2.60	61.3	20.2	3.1	1450	58.2	3.60	46.0	107.2	4.7	4.9
	9.0	1.8	4.0	1550	53.5	36.0	2.69	62.7	19.9	3.1	1650	59.1	3.49	47.2	103.2	5.0	5.0
	12.0	3.3	7.6	1364	53.2	33.6	2.51	61.6	21.2	2.8	1450	59.7	3.65	47.3	108.1	4.8	5.0
	12.0	3.3	7.6	1550	54.1	36.1	2.60	63.0	20.8	2.9	1650	60.6	3.53	48.6	104.0	5.0	5.1
80	6.0	0.7	1.5	1364	48.1	31.8	3.07	58.6	15.7	4.5	1450	60.7	3.68	48.2	108.8	4.8	5.1
	6.0	0.7	1.5	1550	49.0	34.2	3.18	59.8	15.4	4.6	1650	61.6	3.56	49.5	104.6	5.1	5.2
	9.0	1.7	4.0	1364	50.1	32.7	2.87	59.9	17.5	3.8	1450	63.8	3.77	50.9	110.7	5.0	5.4
	9.0	1.7	4.0	1550	51.0	35.1	2.97	61.1	17.2	3.9	1650	64.8	3.65	52.3	106.3	5.2	5.5
	12.0	3.2	7.5	1364	51.1	33.0	2.77	60.4	18.4	3.6	1450	65.5	3.82	52.4	111.8	5.0	5.9
	12.0	3.2	7.5	1550	51.9	35.5	2.87	61.7	18.1	3.6	1650	66.5	3.70	53.8	107.3	5.3	6.0
85	6.0	0.7	1.5	1364	46.5	31.0	3.2	57.5	14.5	5.0	1450	63.4	3.76	50.6	110.5	4.9	5.3
	6.0	0.7	1.5	1550	47.3	33.3	3.35	58.8	14.2	5.1	1650	64.3	3.6	51.9	106.1	5.2	5.4
	9.0	1.7	3.9	1364	48.6	32.0	3.02	58.9	16.2	4.3	1450	66.6	3.8	53.5	112.5	5.1	5.6
	9.0	1.7	3.9	1550	49.4	34.4	3.13	60.1	15.9	4.4	1650	67.6	3.7	54.9	108.0	5.3	5.8
	12.0	3.2	7.4	1364	49.6	32.4	2.92	59.5	17.1	4.0	1450	68.4	3.9	55.1	113.7	5.1	6.0
	12.0	3.2	7.4	1550	50.5	34.8	3.02	60.8	16.8	4.1	1650	69.4	3.8	56.5	109.0	5.4	6.1
90	6.0	0.7	1.5	1364	44.9	30.2	3.39	56.5	13.2	5.5	1450	66.0	3.83	52.9	112.2	5.0	5.6
	6.0	0.7	1.5	1550	45.7	32.5	3.52	57.7	13.0	5.6	1650	67.0	3.72	54.3	107.6	5.3	5.7
	9.0	1.7	3.9	1364	47.1	31.3	3.17	57.9	14.8	4.8	1450	69.4	3.93	56.0	114.3	5.2	5.9
	9.0	1.7	3.9	1550	47.9	33.6	3.29	59.1	14.6	4.9	1650	70.5	3.81	57.5	109.6	5.4	6.0
	12.0	3.2	7.4	1364	48.1	31.8	3.07	58.5	15.7	4.5	1450	71.3	3.98	57.7	115.5	5.3	6.1
	12.0	3.2	7.4	1550	49.0	34.2	3.18	59.8	15.4	4.6	1650	72.4	3.86	59.2	110.6	5.5	6.2
100	6.0	0.6	1.5	1364	41.7	28.6	3.78	54.6	11.1	6.8							
	6.0	0.6	1.5	1550	42.5	30.8	3.91	55.8	10.8	6.9							
	9.0	1.7	3.8	1364	43.7	29.6	3.53	55.8	12.4	6.0							
	9.0	1.7	3.8	1550	44.5	31.8	3.65	57.0	12.2	6.1							
	12.0	3.2	7.3	1364	44.8	30.1	3.41	56.4	13.2	5.6							
110	6.0	0.6	1.4	1364	38.9	27.3	4.23	53.4	9.2	8.2							
	6.0	0.6	1.4	1550	39.5	29.3	4.38	54.5	9.0	8.4							
	9.0	1.6	3.7	1364	40.6	28.0	3.94	54.0	10.3	7.3							
	9.0	1.6	3.7	1550	41.3	30.2	4.09	55.2	10.1	7.4							
	12.0	3.1	7.2	1364	41.5	28.5	3.81	54.5	10.9	6.9							
	12.0	3.1	7.2	1550	42.2	30.6	3.94	55.7	10.7	7.0							
120	6.0	0.6	1.3	1364	36.8	26.6	4.78	53.2	7.7	9.9							
	6.0	0.6	1.3	1550	37.4	28.6	4.96	54.3	7.6	10.1							
	9.0	1.6	3.6	1364	37.9	26.9	4.44	53.1	8.5	8.8							
	9.0	1.6	3.6	1550	38.6	28.9	4.60	54.3	8.4	9.0							
	12.0	3.0	7.0	1364	38.6	27.2	4.28	53.3	9.0	8.3							
12.0	3.0	7.0	1550	39.3	29.2	4.43	54.4	8.9	8.5								

Interpolation is permissible, extrapolation is not. All performance data is based on the lower voltage of dual voltage units.  
 Performance stated is at the rated power supply, performance may vary as the power supply varies from the rated.  
 Table is with entering air of 80°F DB and 67°F WB in cooling, and 70°F DB in heating.  
 AHRI/ISO certified conditions are 80.6°F DB and 66.2°F WB in cooling and 68°F DB in heating.

Table does not reflect fan or pump power corrections for AHRI/ISO conditions.  
 See performance correction tables for operating conditions other than those listed above. See performance data selection notes for operation in the shaded areas.  
 Operation below 40°F EWT is based on a 15% methanol antifreeze solution.  
 Operation below 60°F EWT requires optional extended range insulated water and refrigerant circuits to avoid condensation within the unit cabinet.

## Performance Data – TE H/V/D 064 (Part Load), No vFlow®

1650 CFM Nominal (Rated) Airflow Heating, 1500 CFM Nominal (Rated) Airflow Cooling

Performance capacities shown in thousands of Btuh

EWT °F	GPM	WPD		COOLING - EAT 80/67 °F							HEATING - 70°F						
		PSI	FT	CFM	TC	SC	kW	HR	EER	HWC	CFM	HC	kW	HE	LAT	COP	HWC
20	12.0	5.2	11.9								1450	28.2	2.87	18.7	88.0	2.9	3.1
	12.0	5.2	11.9								1650	28.6	2.75	19.3	86.1	3.1	3.1
30	6.0	0.9	2.1	1320	56.0	38.9	1.47	61.1	38.0	1.0	1450	31.7	2.88	22.1	90.2	3.2	3.1
	6.0	0.9	2.1	1500	57.1	41.6	1.50	62.2	38.1	1.1	1650	32.2	2.76	22.7	88.0	3.4	3.2
	9.0	2.5	5.7	1320	55.8	39.5	1.42	60.6	39.2	1.0	1450	33.1	2.89	23.5	91.1	3.4	3.2
	9.0	2.5	5.7	1500	56.9	42.3	1.45	61.8	39.2	1.0	1650	33.6	2.77	24.1	88.8	3.6	3.2
	12.0	4.2	9.6	1320	55.4	39.8	1.41	60.2	39.2	1.0	1450	33.9	2.89	24.2	91.6	3.4	3.2
	12.0	4.2	9.6	1500	56.5	42.6	1.44	61.4	39.2	1.0	1650	34.4	2.77	24.9	89.3	3.6	3.2
40	6.0	0.5	1.1	1320	55.3	38.0	1.61	60.8	34.4	1.3	1450	37.0	2.91	27.3	93.6	3.7	3.2
	6.0	0.5	1.1	1500	56.4	40.7	1.64	62.0	34.4	1.3	1650	37.6	2.79	28.0	91.1	3.9	3.3
	9.0	1.9	4.4	1320	55.9	38.6	1.51	61.1	37.0	1.1	1450	38.8	2.92	29.0	94.8	3.9	3.3
	9.0	1.9	4.4	1500	57.0	41.3	1.54	62.3	37.0	1.1	1650	39.4	2.80	29.8	92.1	4.1	3.4
	12.0	3.4	7.9	1320	56.0	38.9	1.47	61.0	38.0	1.0	1450	39.8	2.93	30.0	95.4	4.0	3.3
	12.0	3.4	7.9	1500	57.1	41.7	1.50	62.2	38.1	1.1	1650	40.4	2.81	30.8	92.7	4.2	3.4
50	6.0	0.2	0.6	1320	53.7	37.2	1.82	59.9	29.6	1.8	1450	42.5	2.94	32.6	97.1	4.2	3.4
	6.0	0.2	0.6	1500	54.8	39.8	1.85	61.1	29.6	1.8	1650	43.1	2.82	33.5	94.2	4.5	3.5
	9.0	1.5	3.5	1320	54.9	37.8	1.67	60.6	32.9	1.4	1450	44.7	2.96	34.7	98.5	4.4	3.5
	9.0	1.5	3.5	1500	56.0	40.4	1.70	61.8	32.9	1.5	1650	45.3	2.84	35.7	95.4	4.7	3.5
	12.0	3.0	6.9	1320	55.4	38.1	1.60	60.9	34.6	1.3	1450	45.9	2.97	35.9	99.3	4.5	3.5
	12.0	3.0	6.9	1500	56.5	40.8	1.63	62.0	34.6	1.3	1650	46.6	2.85	36.9	96.1	4.8	3.6
60	6.0	0.2	0.4	1320	51.4	36.3	2.07	58.5	24.8	2.4	1450	48.1	2.98	37.9	100.7	4.7	3.6
	6.0	0.2	0.4	1500	52.4	38.9	2.11	59.6	24.8	2.5	1650	48.8	2.86	39.0	97.4	5.0	3.7
	9.0	1.4	3.2	1320	53.0	36.9	1.90	59.5	28.0	2.0	1450	50.6	3.01	40.4	102.3	4.9	3.7
	9.0	1.4	3.2	1500	54.1	39.5	1.93	60.6	28.0	2.0	1650	51.4	2.89	41.5	98.8	5.2	3.8
	12.0	2.7	6.3	1320	53.8	37.2	1.81	59.9	29.8	1.8	1450	52.1	3.02	41.7	103.2	5.0	3.8
	12.0	2.7	6.3	1500	54.8	39.9	1.84	61.1	29.8	1.8	1650	52.8	2.90	42.9	99.6	5.3	3.8
70	6.0	0.2	0.4	1320	48.6	35.4	2.38	56.7	20.5	3.3	1450	53.6	3.04	43.3	104.2	5.2	3.8
	6.0	0.2	0.4	1500	49.6	37.9	2.42	57.8	20.5	3.3	1650	54.4	2.91	44.5	100.5	5.5	3.9
	9.0	1.3	3.0	1320	50.5	36.0	2.17	57.9	23.3	2.7	1450	56.5	3.07	46.0	106.1	5.4	4.0
	9.0	1.3	3.0	1500	51.5	38.6	2.21	59.0	23.3	2.7	1650	57.3	2.94	47.3	102.2	5.7	4.1
	12.0	2.6	6.0	1320	51.4	36.3	2.07	58.5	24.8	2.4	1450	58.1	3.09	47.5	107.1	5.5	4.1
	12.0	2.6	6.0	1500	52.4	38.9	2.11	59.6	24.8	2.5	1650	58.9	2.96	48.8	103.1	5.8	4.2
80	6.0	0.3	0.6	1320	45.6	34.3	2.73	54.9	16.7	4.3	1450	59.1	3.10	48.5	107.7	5.6	4.1
	6.0	0.3	0.6	1500	46.5	36.7	2.78	56.0	16.7	4.4	1650	59.9	2.97	49.8	103.6	5.9	4.2
	9.0	1.3	3.1	1320	47.5	35.0	2.50	56.1	19.0	3.6	1450	62.2	3.13	51.5	109.7	5.8	4.3
	9.0	1.3	3.1	1500	48.5	37.5	2.55	57.2	19.0	3.7	1650	63.1	3.00	52.9	105.4	6.2	4.4
	12.0	2.6	5.9	1320	48.5	35.3	2.40	56.7	20.2	3.3	1450	63.9	3.16	53.0	110.8	5.9	4.4
	12.0	2.6	5.9	1500	49.5	37.8	2.44	57.8	20.3	3.4	1650	64.8	3.03	54.5	106.4	6.3	4.5
85	6.0	0.3	0.7	1320	44.0	33.6	2.9	54.0	15.1	4.9	1450	61.8	3.13	51.0	109.4	5.8	4.3
	6.0	0.3	0.7	1500	44.9	36.0	2.98	55.0	15.2	5.0	1650	62.6	3.0	52.4	105.1	6.1	4.4
	9.0	1.4	3.2	1320	46.0	34.4	2.69	55.1	17.2	4.2	1450	65.0	3.2	54.0	111.5	6.0	4.5
	9.0	1.4	3.2	1500	46.8	36.8	2.74	56.2	17.2	4.2	1650	65.9	3.0	55.5	107.0	6.4	4.6
	12.0	2.6	5.9	1320	46.9	34.8	2.58	55.7	18.3	3.8	1450	66.7	3.2	55.6	112.6	6.1	4.6
	12.0	2.6	5.9	1500	47.9	37.2	2.63	56.8	18.4	3.9	1650	67.6	3.1	57.2	108.0	6.5	4.7
90	6.0	0.3	0.7	1320	42.4	33.0	3.12	53.1	13.6	5.5	1450	64.4	3.16	53.5	111.1	6.0	4.5
	6.0	0.3	0.7	1500	43.3	35.3	3.18	54.1	13.6	5.6	1650	65.3	3.03	55.0	106.7	6.3	4.6
	9.0	1.4	3.2	1320	44.4	33.8	2.88	54.2	15.4	4.7	1450	67.7	3.21	56.6	113.2	6.2	4.7
	9.0	1.4	3.2	1500	45.2	36.2	2.93	55.2	15.4	4.8	1650	68.7	3.08	58.2	108.5	6.5	4.8
	12.0	2.6	6.0	1320	45.4	34.2	2.76	54.8	16.4	4.4	1450	69.4	3.24	58.2	114.3	6.3	4.9
	12.0	2.6	6.0	1500	46.2	36.6	2.81	55.8	16.5	4.4	1650	70.4	3.11	59.8	109.5	6.6	4.9
100	6.0	0.3	0.8	1320	39.4	31.6	3.55	51.5	11.1	6.9							
	6.0	0.3	0.8	1500	40.2	33.9	3.62	52.5	11.1	7.0							
	9.0	1.4	3.2	1320	41.2	32.4	3.30	52.4	12.5	6.0							
	9.0	1.4	3.2	1500	42.0	34.7	3.36	53.4	12.5	6.1							
	12.0	2.6	6.0	1320	42.1	32.9	3.17	52.9	13.3	5.6							
	12.0	2.6	6.0	1500	43.0	35.2	3.23	54.0	13.3	5.7							
110	6.0	0.3	0.6	1320	36.7	30.2	4.02	50.4	9.1	8.5							
	6.0	0.3	0.6	1500	37.4	32.4	4.09	51.3	9.1	8.7							
	9.0	1.3	3.1	1320	38.2	31.0	3.74	51.0	10.2	7.5							
	9.0	1.3	3.1	1500	38.9	33.2	3.81	52.0	10.2	7.7							
	12.0	2.5	5.8	1320	39.0	31.4	3.61	51.4	10.8	7.1							
	12.0	2.5	5.8	1500	39.8	33.7	3.68	52.3	10.8	7.2							
120	6.0	0.0	0.0	1320	34.4	28.9	4.51	49.8	7.6	10.3							
	6.0	0.0	0.0	1500	35.1	31.0	4.59	50.8	7.6	10.5							
	9.0	1.1	2.6	1320	35.6	29.6	4.22	50.0	8.4	9.3							
	9.0	1.1	2.6	1500	36.3	31.7	4.30	51.0	8.4	9.4							
	12.0	2.4	5.4	1320	36.3	30.0	4.09	50.2	8.9	8.7							
	12.0	2.4	5.4	1500	37.0	32.2	4.16	51.2	8.9	8.9							

Interpolation is permissible, extrapolation is not. All performance data is based on the lower voltage of dual voltage units.  
 Performance stated is at the rated power supply, performance may vary as the power supply varies from the rated.  
 Table is with entering air of 80°F DB and 67°F WB in cooling, and 70°F DB in heating.  
 AHR/ISO certified conditions are 80.6°F DB and 66.2°F WB in cooling and 68°F DB in heating.  
 Table does not reflect fan or pump power corrections for AHR/ISO conditions.

See performance correction tables for operating conditions other than those listed above. See performance data selection notes for operation in the shaded areas.  
 Operation below 40°F EWT is based on a 15% methanol antifreeze solution.  
 Operation below 60°F EWT requires optional extended range insulated water and refrigerant circuits to avoid condensation within the unit cabinet.

# Performance Data – TE H/V/D 064 (Full Load), No vFlow®

2050 CFM Nominal (Rated) Airflow Heating, 1850 CFM Nominal (Rated) Airflow Cooling

Performance capacities shown in thousands of Btuh

EWT °F	GPM	WPD		COOLING - EAT 80/67 °F							HEATING - 70°F						
		PSI	FT	CFM	TC	SC	kW	HR	EER	HWC	CFM	HC	kW	HE	LAT	COP	HWC
20	15.0	7.3	16.8								1800	42.8	3.89	29.8	92.0	3.2	3.8
	15.0	7.3	16.8								2050	43.5	3.77	30.6	89.6	3.4	3.8
30	7.5	1.7	3.9	1630	75.3	49.7	2.68	84.3	28.1	1.9	1800	46.9	3.94	33.6	94.1	3.5	3.9
	7.5	1.7	3.9	1850	76.6	53.4	2.78	86.1	27.5	2.0	2050	47.6	3.82	34.5	91.5	3.7	4.0
	11.3	3.7	8.6	1630	74.9	50.3	2.58	83.5	29.1	1.8	1800	49.1	3.98	35.8	95.3	3.6	4.0
	11.3	3.7	8.6	1850	76.2	54.0	2.67	85.3	28.5	1.8	2050	49.9	3.86	36.7	92.5	3.8	4.1
	15.0	6.1	14.1	1630	74.2	50.5	2.53	82.7	29.4	1.8	1800	50.4	4.00	36.9	95.9	3.7	4.0
	15.0	6.1	14.1	1850	75.5	54.3	2.62	84.5	28.8	1.8	2050	51.2	3.88	37.9	93.1	3.9	4.1
40	7.5	1.2	2.7	1630	74.4	48.8	2.87	84.0	26.0	2.3	1800	53.9	4.07	40.2	97.7	3.9	4.2
	7.5	1.2	2.7	1850	75.7	52.5	2.97	85.8	25.5	2.3	2050	54.7	3.94	41.3	94.7	4.1	4.2
	11.3	3.0	7.0	1630	75.2	49.5	2.72	84.3	27.6	2.0	1800	56.7	4.12	42.8	99.2	4.0	4.3
	11.3	3.0	7.0	1850	76.5	53.2	2.82	86.1	27.1	2.1	2050	57.6	3.99	44.0	96.0	4.2	4.4
	15.0	5.3	12.2	1630	75.3	49.8	2.66	84.2	28.3	1.9	1800	58.3	4.15	44.3	100.0	4.1	4.3
	15.0	5.3	12.2	1850	76.6	53.6	2.76	86.0	27.7	1.9	2050	59.2	4.02	45.5	96.7	4.3	4.4
50	7.5	0.9	2.0	1630	72.4	47.8	3.09	82.8	23.4	2.8	1800	61.1	4.21	46.9	101.5	4.3	4.5
	7.5	0.9	2.0	1850	73.6	51.4	3.20	84.5	23.0	2.9	2050	62.1	4.08	48.2	98.0	4.5	4.6
	11.3	2.6	6.0	1630	74.0	48.6	2.91	83.8	25.4	2.4	1800	64.5	4.28	50.0	103.2	4.4	4.6
	11.3	2.6	6.0	1850	75.3	52.2	3.02	85.6	24.9	2.5	2050	65.5	4.15	51.3	99.6	4.6	4.7
	15.0	4.7	10.8	1630	74.6	48.9	2.84	84.1	26.3	2.2	1800	66.3	4.32	51.7	104.1	4.5	4.7
	15.0	4.7	10.8	1850	75.9	52.6	2.94	85.9	25.8	2.3	2050	67.3	4.19	53.0	100.4	4.7	4.8
60	7.5	0.8	1.7	1630	69.5	46.7	3.35	80.9	20.8	3.5	1800	68.5	4.38	53.6	105.2	4.6	4.9
	7.5	0.8	1.7	1850	70.7	50.3	3.47	82.6	20.4	3.6	2050	69.5	4.24	55.1	101.4	4.8	5.0
	11.3	2.4	5.4	1630	71.7	47.6	3.15	82.3	22.8	3.0	1800	72.3	4.47	57.1	107.2	4.7	5.1
	11.3	2.4	5.4	1850	73.0	51.1	3.26	84.1	22.4	3.1	2050	73.4	4.33	58.6	103.2	5.0	5.2
	15.0	4.3	10.0	1630	72.7	48.0	3.05	83.0	23.8	2.8	1800	74.4	4.52	59.0	108.3	4.8	5.2
	15.0	4.3	10.0	1850	74.0	51.6	3.16	84.8	23.4	2.8	2050	75.5	4.38	60.6	104.1	5.1	5.3
70	7.5	0.7	1.7	1630	66.1	45.5	3.68	78.6	18.0	4.4	1800	75.8	4.55	60.3	109.0	4.9	5.3
	7.5	0.7	1.7	1850	67.3	48.9	3.81	80.3	17.7	4.5	2050	77.0	4.41	61.9	104.8	5.1	5.4
	11.3	2.3	5.2	1630	68.6	46.4	3.44	80.3	20.0	3.8	1800	80.1	4.66	64.2	111.2	5.0	5.6
	11.3	2.3	5.2	1850	69.8	49.9	3.56	82.0	19.6	3.8	2050	81.3	4.52	65.9	106.7	5.3	5.7
	15.0	4.1	9.6	1630	69.9	46.9	3.32	81.1	21.0	3.5	1800	82.4	4.74	66.3	112.4	5.1	5.7
	15.0	4.1	9.6	1850	71.1	50.4	3.44	82.8	20.7	3.5	2050	83.7	4.59	68.0	107.8	5.3	5.8
80	7.5	0.8	1.8	1630	62.5	44.1	4.04	76.2	15.4	5.5	1800	83.1	4.76	66.9	112.8	5.1	5.8
	7.5	0.8	1.8	1850	63.5	47.5	4.19	77.8	15.2	5.6	2050	84.4	4.61	68.7	108.1	5.4	5.9
	11.3	2.2	5.2	1630	65.1	45.1	3.77	77.9	17.2	4.7	1800	87.8	4.89	71.1	115.2	5.3	6.1
	11.3	2.2	5.2	1850	66.2	48.5	3.91	79.6	16.9	4.8	2050	89.1	4.74	73.0	110.3	5.5	6.2
	15.0	4.1	9.4	1630	66.4	45.6	3.65	78.7	18.2	4.3	1800	90.3	4.96	73.3	116.5	5.3	6.7
	15.0	4.1	9.4	1850	67.5	49.0	3.78	80.4	17.9	4.4	2050	91.7	4.81	75.3	111.4	5.6	6.9
85	7.5	0.6	1.3	1630	60.6	43.4	4.3	75.1	14.3	6.1	1800	86.7	4.86	70.1	114.6	5.2	6.0
	7.5	0.6	1.3	1850	61.6	46.7	4.42	76.7	14.0	6.2	2050	88.0	4.7	72.0	109.8	5.5	6.2
	11.3	1.8	4.2	1630	63.2	44.4	3.98	76.7	16.0	5.3	1800	91.5	5.0	74.4	117.1	5.4	6.4
	11.3	1.8	4.2	1850	64.3	47.7	4.12	78.3	15.7	5.4	2050	92.9	4.9	76.3	112.0	5.6	6.5
	15.0	3.3	7.7	1630	64.5	44.9	3.84	77.5	16.9	4.9	1800	94.1	5.1	76.7	118.4	5.4	6.8
	15.0	3.3	7.7	1850	65.6	48.3	3.98	79.2	16.6	5.0	2050	95.5	4.9	78.7	113.1	5.7	7.0
90	7.5	0.3	0.7	1630	58.7	42.6	4.49	74.0	13.1	6.7	1800	90.3	4.96	73.3	116.4	5.3	6.3
	7.5	0.3	0.7	1850	59.8	45.8	4.65	75.6	12.8	6.8	2050	91.7	4.81	75.2	111.4	5.6	6.4
	11.3	1.4	3.2	1630	61.3	43.7	4.18	75.5	14.7	5.8	1800	95.2	5.12	77.7	119.0	5.5	6.7
	11.3	1.4	3.2	1850	62.3	47.0	4.33	77.1	14.4	6.0	2050	96.7	4.96	79.7	113.7	5.7	6.9
	15.0	2.6	6.0	1630	62.6	44.2	4.03	76.3	15.5	5.4	1800	97.9	5.21	80.0	120.3	5.5	7.0
	15.0	2.6	6.0	1850	63.7	47.5	4.18	77.9	15.2	5.5	2050	99.4	5.05	82.1	114.9	5.8	7.1
100	7.5	0.3	0.8	1630	55.2	41.1	5.00	72.3	11.0	8.1							
	7.5	0.3	0.8	1850	56.2	44.2	5.18	73.9	10.8	8.3							
	11.3	1.4	3.2	1630	57.5	42.1	4.65	73.4	12.4	7.2							
	11.3	1.4	3.2	1850	58.5	45.3	4.82	75.0	12.1	7.3							
	15.0	2.6	6.0	1630	58.8	42.6	4.49	74.0	13.1	6.7							
	15.0	2.6	6.0	1850	59.8	45.9	4.65	75.6	12.9	6.8							
110	7.5	0.3	0.6	1630	52.2	39.6	5.60	71.4	9.3	9.8							
	7.5	0.3	0.6	1850	53.1	42.6	5.80	72.9	9.2	10.0							
	11.3	1.3	3.1	1630	54.1	40.6	5.20	71.9	10.4	8.7							
	11.3	1.3	3.1	1850	55.0	43.6	5.39	73.4	10.2	8.9							
	15.0	2.5	5.8	1630	55.2	41.1	5.01	72.3	11.0	8.2							
	15.0	2.5	5.8	1850	56.1	44.2	5.19	73.8	10.8	8.3							
120	7.5	0.0	0.0	1630	50.0	38.5	6.30	71.6	7.9	11.7							
	7.5	0.0	0.0	1850	50.8	41.4	6.53	73.1	7.8	11.9							
	11.3	1.1	2.6	1630	51.3	39.2	5.83	71.3	8.8	10.4							
	11.3	1.1	2.6	1850	52.2	42.1	6.04	72.8	8.6	10.6							
	15.0	2.4	5.4	1630	52.1	39.6	5.62	71.3	9.3	9.8							
	15.0	2.4	5.4	1850	53.0	42.6	5.82	72.9	9.1	10.0							

Interpolation is permissible, extrapolation is not. All performance data is based on the lower voltage of dual voltage units.  
 Performance stated is at the rated power supply, performance may vary as the power supply varies from the rated.  
 Table is with entering air of 80°F DB and 67°F WB in cooling, and 70°F DB in heating.  
 AHRI/ISO certified conditions are 80.6°F DB and 66.2°F WB in cooling and 68°F DB in heating.

Table does not reflect fan or pump power corrections for AHRI/ISO conditions.  
 See performance correction tables for operating conditions other than those listed above. See performance data selection notes for operation in the shaded areas.  
 Operation below 40°F EWT is based on a 15% methanol antifreeze solution.  
 Operation below 60°F EWT requires optional extended range insulated water and refrigerant circuits to avoid condensation within the unit cabinet.

## Performance Data – TE H/V/D 072 (Part Load), No vFlow®

1650 CFM Nominal (Rated) Airflow Heating, 1550 CFM Nominal (Rated) Airflow Cooling

Performance capacities shown in thousands of Btu/h

EWT °F	GPM	WPD		COOLING - EAT 80/67 °F							HEATING - 70°F						
		PSI	FT	CFM	TC	SC	kW	HR	EER	HWC	CFM	HC	kW	HE	LAT	COP	HWC
20	14.0	6.5	15.1								1450	32.9	3.66	20.9	91.0	2.6	4.1
	14.0	6.5	15.1								1650	33.4	3.51	21.4	88.7	2.8	4.1
30	7.0	1.4	3.3	1360	65.1	40.9	1.82	71.3	35.8	2.2	1450	37.2	3.72	24.8	93.7	2.9	4.2
	7.0	1.4	3.3	1550	66.4	43.8	1.85	72.7	35.9	2.2	1650	37.7	3.57	25.5	91.1	3.1	4.3
	10.5	3.3	7.6	1360	65.5	41.3	1.72	71.3	38.1	2.2	1450	38.7	3.74	26.3	94.7	3.0	4.2
	10.5	3.3	7.6	1550	66.7	44.2	1.75	72.7	38.1	2.2	1650	39.3	3.59	27.0	92.0	3.2	4.3
	14.0	5.4	12.5	1360	65.5	41.4	1.68	71.2	39.0	2.2	1450	39.6	3.75	27.1	95.3	3.1	4.2
	14.0	5.4	12.5	1550	66.7	44.4	1.71	72.6	39.0	2.3	1650	40.1	3.60	27.8	92.5	3.3	4.3
40	7.0	0.9	2.2	1360	63.8	40.1	2.01	70.7	31.7	2.3	1450	43.3	3.81	30.6	97.6	3.3	4.4
	7.0	0.9	2.2	1550	65.0	43.0	2.05	72.0	31.7	2.4	1650	43.9	3.65	31.4	94.6	3.5	4.5
	10.5	2.6	6.1	1360	64.8	40.7	1.88	71.2	34.5	2.2	1450	45.2	3.84	32.4	98.9	3.5	4.4
	10.5	2.6	6.1	1550	66.0	43.6	1.91	72.5	34.6	2.2	1650	45.8	3.68	33.3	95.7	3.7	4.5
	14.0	4.6	10.7	1360	65.1	40.9	1.81	71.3	36.0	2.2	1450	46.3	3.85	33.4	99.5	3.5	4.4
	14.0	4.6	10.7	1550	66.4	43.8	1.84	72.7	36.1	2.2	1650	46.9	3.69	34.3	96.3	3.7	4.5
50	7.0	0.7	1.5	1360	61.7	39.2	2.28	69.5	27.1	2.6	1450	49.4	3.90	36.3	101.5	3.7	4.7
	7.0	0.7	1.5	1550	62.9	41.9	2.32	70.8	27.1	2.7	1650	50.1	3.74	37.4	98.1	3.9	4.8
	10.5	2.2	5.1	1360	63.2	39.8	2.09	70.3	30.2	2.4	1450	51.7	3.93	38.5	103.0	3.9	4.8
	10.5	2.2	5.1	1550	64.4	42.7	2.13	71.7	30.3	2.5	1650	52.5	3.77	39.6	99.4	4.1	4.9
	14.0	4.1	9.4	1360	63.8	40.2	2.01	70.7	31.7	2.4	1450	53.0	3.94	39.7	103.8	3.9	4.8
	14.0	4.1	9.4	1550	65.1	43.0	2.05	72.1	31.7	2.5	1650	53.8	3.78	40.8	100.2	4.2	4.9
60	7.0	0.5	1.3	1360	59.1	38.1	2.60	68.0	22.7	3.2	1450	55.6	3.98	42.2	105.5	4.1	5.1
	7.0	0.5	1.3	1550	60.2	40.8	2.65	69.3	22.7	3.2	1650	56.4	3.82	43.3	101.6	4.3	5.2
	10.5	2.0	4.6	1360	60.9	38.8	2.38	69.0	25.6	2.8	1450	58.3	4.03	44.7	107.2	4.2	5.2
	10.5	2.0	4.6	1550	62.1	41.6	2.42	70.4	25.7	2.9	1650	59.1	3.86	46.0	103.2	4.5	5.3
	14.0	3.8	8.7	1360	61.8	39.2	2.28	69.5	27.1	2.7	1450	59.8	4.05	46.1	108.2	4.3	5.3
	14.0	3.8	8.7	1550	63.0	42.0	2.32	70.9	27.1	2.7	1650	60.6	3.88	47.4	104.0	4.6	5.4
70	7.0	0.5	1.3	1360	56.0	36.9	2.99	66.2	18.8	4.2	1450	61.8	4.07	48.0	109.4	4.4	5.5
	7.0	0.5	1.3	1550	57.1	39.5	3.04	67.5	18.8	4.3	1650	62.6	3.90	49.3	105.1	4.7	5.6
	10.5	1.9	4.5	1360	58.1	37.7	2.73	67.4	21.3	3.6	1450	64.8	4.12	50.9	111.4	4.6	5.7
	10.5	1.9	4.5	1550	59.2	40.3	2.78	68.7	21.3	3.7	1650	65.8	3.95	52.3	106.9	4.9	5.8
	14.0	3.6	8.3	1360	59.1	38.1	2.60	67.9	22.7	3.4	1450	66.5	4.14	52.5	112.5	4.7	5.8
	14.0	3.6	8.3	1550	60.2	40.7	2.65	69.3	22.7	3.5	1650	67.5	3.97	53.9	107.9	5.0	5.9
80	7.0	0.6	1.4	1360	52.7	35.6	3.42	64.3	15.4	5.7	1450	68.0	4.16	53.8	113.4	4.8	6.0
	7.0	0.6	1.4	1550	53.7	38.1	3.48	65.6	15.4	5.8	1650	68.9	3.99	55.3	108.7	5.1	6.1
	10.5	1.9	4.5	1360	54.8	36.4	3.13	65.5	17.5	4.9	1450	71.4	4.22	57.0	115.6	5.0	6.2
	10.5	1.9	4.5	1550	55.9	39.0	3.19	66.8	17.5	5.0	1650	72.4	4.05	58.6	110.6	5.2	6.3
	14.0	3.5	8.1	1360	55.9	36.8	3.00	66.1	18.7	4.5	1450	73.3	4.26	58.8	116.8	5.0	6.4
	14.0	3.5	8.1	1550	57.0	39.4	3.05	67.4	18.7	4.6	1650	74.3	4.08	60.4	111.7	5.3	6.5
85	7.0	0.6	1.5	1360	50.9	34.9	3.7	63.4	14.0	6.6	1450	71.1	4.21	56.7	115.4	4.9	6.2
	7.0	0.6	1.5	1550	51.9	37.4	3.73	64.6	14.0	6.7	1650	72.1	4.0	58.3	110.4	5.2	6.4
	10.5	1.9	4.5	1360	53.1	35.7	3.37	64.6	15.9	5.7	1450	74.7	4.3	60.1	117.7	5.1	6.5
	10.5	1.9	4.5	1550	54.1	38.2	3.43	65.8	15.9	5.8	1650	75.8	4.1	61.8	112.5	5.4	6.6
	14.0	3.5	8.1	1360	54.2	36.1	3.22	65.2	16.9	5.3	1450	76.7	4.3	61.9	119.0	5.2	6.7
	14.0	3.5	8.1	1550	55.2	38.7	3.28	66.4	17.0	5.4	1650	77.8	4.1	63.7	113.6	5.5	6.8
90	7.0	0.7	1.5	1360	49.1	34.2	3.91	62.5	12.6	7.5	1450	74.1	4.27	59.6	117.3	5.1	6.5
	7.0	0.7	1.5	1550	50.1	36.6	3.98	63.7	12.6	7.6	1650	75.2	4.09	61.2	112.2	5.4	6.6
	10.5	2.0	4.5	1360	51.3	35.0	3.60	63.6	14.2	6.5	1450	78.0	4.33	63.2	119.8	5.3	6.8
	10.5	2.0	4.5	1550	52.3	37.5	3.67	64.8	14.3	6.7	1650	79.1	4.15	64.9	114.4	5.6	7.0
	14.0	3.5	8.1	1360	52.4	35.5	3.45	64.2	15.2	6.1	1450	80.1	4.37	65.1	121.1	5.4	7.0
	14.0	3.5	8.1	1550	53.5	38.0	3.51	65.4	15.2	6.2	1650	81.2	4.19	66.9	115.6	5.7	7.1
100	7.0	0.7	1.6	1360	45.5	32.9	4.46	60.7	10.2	9.7							
	7.0	0.7	1.6	1550	46.4	35.2	4.54	61.9	10.2	9.9							
	10.5	2.0	4.5	1360	47.7	33.7	4.12	61.7	11.6	8.6							
	10.5	2.0	4.5	1550	48.6	36.0	4.20	62.9	11.6	8.8							
	14.0	3.5	8.1	1360	48.8	34.1	3.96	62.3	12.3	8.1							
	14.0	3.5	8.1	1550	49.7	36.5	4.03	63.5	12.3	8.2							
110	7.0	0.6	1.4	1360	42.0	31.5	5.06	59.3	8.3	12.4							
	7.0	0.6	1.4	1550	42.9	33.8	5.15	60.4	8.3	12.6							
	10.5	1.9	4.4	1360	44.1	32.3	4.69	60.1	9.4	11.1							
	10.5	1.9	4.4	1550	44.9	34.6	4.78	61.2	9.4	11.3							
	14.0	3.5	8.0	1360	45.1	32.7	4.53	60.5	10.0	10.5							
	14.0	3.5	8.0	1550	46.0	35.0	4.61	61.7	10.0	10.7							
120	7.0	0.4	0.9	1360	38.7	30.3	5.72	58.2	6.8	15.4							
	7.0	0.4	0.9	1550	39.5	32.5	5.82	59.4	6.8	15.7							
	10.5	1.7	3.9	1360	40.6	31.0	5.33	58.8	7.6	14.0							
	10.5	1.7	3.9	1550	41.4	33.2	5.43	59.9	7.6	14.3							
	14.0	3.3	7.6	1360	41.6	31.3	5.15	59.1	8.1	13.3							
	14.0	3.3	7.6	1550	42.4	33.6	5.24	60.2	8.1	13.6							

Interpolation is permissible, extrapolation is not. All performance data is based on the lower voltage of dual voltage units.  
 Performance stated is at the rated power supply, performance may vary as the power supply varies from the rated.  
 Table is with entering air of 80°F DB and 67°F WB in cooling, and 70°F DB in heating.  
 AHRI/ISO certified conditions are 80.6°F DB and 66.2°F WB in cooling and 68°F DB in heating.

Table does not reflect fan or pump power corrections for AHRI/ISO conditions.  
 See performance correction tables for operating conditions other than those listed above. See performance data selection notes for operation in the shaded areas.  
 Operation below 40°F EWT is based on a 15% methanol antifreeze solution.  
 Operation below 60°F EWT requires optional extended range insulated water and refrigerant circuits to avoid condensation within the unit cabinet.

Performance Data – TE H/V/D 072 (Full Load), No vFlow®

2050 CFM Nominal (Rated) Airflow Heating, 1850 CFM Nominal (Rated) Airflow Cooling

Performance capacities shown in thousands of Btu/h

EWT °F	GPM	WPD			COOLING - EAT 80/67 °F						HEATING - 70°F							
		PSI	FT		CFM	TC	SC	kW	HR	EER	HWC	CFM	HC	kW	HE	LAT	COP	HWC
20	17.0	8.9	20.6									1800	46.6	4.66	31.1	94.0	2.9	4.0
	17.0	8.9	20.6									2050	47.3	4.52	31.9	91.4	3.1	4.1
30	8.5	2.2	5.1	1630	82.4	50.1	3.04	92.6	27.1	2.2	1800	51.6	4.78	35.6	96.5	3.2	4.2	
	8.5	2.2	5.1	1850	83.8	53.9	3.15	94.6	26.6	2.2	2050	52.4	4.63	36.6	93.7	3.3	4.3	
	12.8	4.6	10.6	1630	82.3	50.0	2.90	92.0	28.4	2.2	1800	54.0	4.83	37.8	97.8	3.3	4.1	
	12.8	4.6	10.6	1850	83.7	53.8	3.00	93.9	27.9	2.2	2050	54.8	4.68	38.8	94.8	3.4	4.2	
	17.0	7.6	17.6	1630	81.9	49.8	2.84	91.4	28.9	2.2	1800	55.3	4.86	39.0	98.4	3.3	4.1	
	17.0	7.6	17.6	1850	83.3	53.5	2.94	93.3	28.3	2.3	2050	56.1	4.71	40.1	95.3	3.5	4.2	
40	8.5	1.6	3.8	1630	81.3	49.8	3.27	92.3	24.9	2.4	1800	59.4	4.95	42.7	100.5	3.5	4.3	
	8.5	1.6	3.8	1850	82.7	53.5	3.39	94.3	24.4	2.4	2050	60.3	4.80	43.9	97.2	3.7	4.4	
	12.8	3.9	8.9	1630	82.2	50.1	3.10	92.6	26.5	2.2	1800	62.1	5.03	45.3	102.0	3.6	4.4	
	12.8	3.9	8.9	1850	83.6	53.9	3.21	94.6	26.1	2.2	2050	63.1	4.87	46.5	98.5	3.8	4.5	
	17.0	6.7	15.5	1630	82.4	50.1	3.02	92.5	27.3	2.2	1800	63.6	5.06	46.6	102.7	3.7	4.4	
	17.0	6.7	15.5	1850	83.8	53.9	3.13	94.5	26.8	2.2	2050	64.6	4.90	47.9	99.2	3.9	4.5	
50	8.5	1.3	3.0	1630	79.1	49.0	3.54	91.0	22.3	2.7	1800	66.9	5.15	49.6	104.4	3.8	4.6	
	8.5	1.3	3.0	1850	80.5	52.6	3.67	93.0	21.9	2.8	2050	67.9	4.99	50.9	100.7	4.0	4.7	
	12.8	3.4	7.8	1630	80.8	49.6	3.34	92.0	24.2	2.4	1800	70.1	5.23	52.5	106.1	3.9	4.7	
	12.8	3.4	7.8	1850	82.2	53.3	3.46	94.0	23.8	2.5	2050	71.2	5.07	53.9	102.1	4.1	4.8	
	17.0	6.0	13.9	1630	81.5	49.8	3.24	92.4	25.1	2.5	1800	71.8	5.27	54.0	106.9	4.0	4.8	
	17.0	6.0	13.9	1850	82.9	53.6	3.36	94.3	24.7	2.5	2050	72.9	5.11	55.5	102.9	4.2	4.9	
60	8.5	1.2	2.7	1630	76.1	47.8	3.87	89.2	19.7	3.3	1800	74.4	5.35	56.4	108.3	4.1	5.0	
	8.5	1.2	2.7	1850	77.4	51.4	4.01	91.1	19.3	3.3	2050	75.5	5.18	57.9	104.1	4.3	5.1	
	12.8	3.1	7.1	1630	78.3	48.7	3.63	90.6	21.6	2.9	1800	78.0	5.45	59.6	110.1	4.2	5.1	
	12.8	3.1	7.1	1850	79.7	52.3	3.76	92.5	21.2	2.9	2050	79.2	5.28	61.2	105.8	4.4	5.2	
	17.0	5.6	13.0	1630	79.3	49.1	3.51	91.2	22.6	2.7	1800	80.0	5.50	61.4	111.1	4.3	5.2	
	17.0	5.6	13.0	1850	80.7	52.7	3.64	93.1	22.2	2.8	2050	81.2	5.33	63.0	106.7	4.5	5.3	
70	8.5	1.1	2.6	1630	72.4	46.3	4.27	86.9	17.0	4.4	1800	81.9	5.55	63.1	112.1	4.3	5.4	
	8.5	1.1	2.6	1850	73.7	49.8	4.42	88.7	16.7	4.5	2050	83.2	5.38	64.8	107.6	4.5	5.5	
	12.8	3.0	6.8	1630	75.0	47.4	3.98	88.5	18.9	3.7	1800	86.0	5.68	66.7	114.2	4.4	5.6	
	12.8	3.0	6.8	1850	76.3	50.9	4.12	90.4	18.5	3.8	2050	87.3	5.50	68.5	109.4	4.7	5.7	
	17.0	5.4	12.4	1630	76.3	47.9	3.85	89.3	19.8	3.5	1800	88.2	5.75	68.7	115.4	4.5	5.7	
	17.0	5.4	12.4	1850	77.6	51.5	3.99	91.2	19.5	3.5	2050	89.5	5.57	70.5	110.4	4.7	5.8	
80	8.5	1.2	2.7	1630	68.4	44.7	4.72	84.4	14.5	5.9	1800	89.5	5.79	69.9	116.0	4.5	5.9	
	8.5	1.2	2.7	1850	69.5	48.1	4.89	86.2	14.2	6.0	2050	90.9	5.61	71.7	111.0	4.7	6.0	
	12.8	2.9	6.7	1630	71.2	45.8	4.40	86.1	16.2	5.0	1800	94.1	5.93	73.9	118.4	4.6	6.1	
	12.8	2.9	6.7	1850	72.4	49.3	4.56	88.0	15.9	5.1	2050	95.5	5.75	75.9	113.2	4.9	6.3	
	17.0	5.2	12.1	1630	72.6	46.4	4.25	87.0	17.1	4.6	1800	96.7	6.02	76.2	119.7	4.7	6.3	
	17.0	5.2	12.1	1850	73.8	49.9	4.40	88.8	16.8	4.7	2050	98.1	5.83	78.2	114.3	4.9	6.4	
85	8.5	1.2	2.7	1630	66.2	43.8	5.0	83.2	13.3	6.8	1800	93.4	5.91	73.3	118.0	4.6	6.1	
	8.5	1.2	2.7	1850	67.4	47.1	5.17	85.0	13.1	6.9	2050	94.8	5.7	75.3	112.8	4.8	6.3	
	12.8	2.9	6.7	1630	69.1	45.0	4.65	84.9	14.9	5.8	1800	98.3	6.1	77.7	120.6	4.7	6.4	
	12.8	2.9	6.7	1850	70.3	48.4	4.82	86.7	14.7	6.0	2050	99.8	5.9	79.7	115.1	5.0	6.6	
	17.0	5.2	12.1	1630	70.5	45.6	4.48	85.7	15.8	5.4	1800	101.1	6.2	80.1	122.0	4.8	6.6	
	17.0	5.2	12.1	1850	71.7	49.0	4.64	87.6	15.5	5.5	2050	102.6	6.0	82.2	116.4	5.0	6.8	
90	8.5	1.2	2.8	1630	64.1	43.0	5.26	82.0	12.2	7.7	1800	97.3	6.04	76.8	120.0	4.7	6.4	
	8.5	1.2	2.8	1850	65.2	46.2	5.45	83.8	12.0	7.9	2050	98.8	5.85	78.8	114.6	4.9	6.5	
	12.8	2.9	6.7	1630	67.0	44.1	4.89	83.6	13.7	6.7	1800	102.6	6.22	81.4	122.8	4.8	6.7	
	12.8	2.9	6.7	1850	68.1	47.4	5.07	85.4	13.4	6.8	2050	104.1	6.03	83.6	117.0	5.1	6.9	
	17.0	5.2	12.0	1630	68.4	44.7	4.71	84.5	14.5	6.2	1800	105.5	6.32	84.0	124.3	4.9	6.9	
	17.0	5.2	12.0	1850	69.6	48.1	4.88	86.3	14.3	6.3	2050	107.1	6.12	86.2	118.4	5.1	7.1	
100	8.5	1.2	2.8	1630	59.8	41.2	5.88	79.9	10.2	10.0								
	8.5	1.2	2.8	1850	60.9	44.3	6.09	81.6	10.0	10.2								
	12.8	2.9	6.7	1630	62.6	42.3	5.46	81.3	11.5	8.8								
	12.8	2.9	6.7	1850	63.7	45.5	5.66	83.0	11.3	9.0								
	17.0	5.2	12.0	1630	64.0	42.9	5.27	82.0	12.2	8.2								
	17.0	5.2	12.0	1850	65.1	46.2	5.46	83.8	11.9	8.4								
110	8.5	1.1	2.6	1630	55.7	39.5	6.61	78.3	8.4	12.7								
	8.5	1.1	2.6	1850	56.7	42.5	6.85	80.0	8.3	13.0								
	12.8	2.9	6.6	1630	58.3	40.6	6.14	79.3	9.5	11.3								
	12.8	2.9	6.6	1850	59.3	43.6	6.36	81.0	9.3	11.5								
	17.0	5.1	11.8	1630	59.6	41.1	5.91	79.9	10.1	10.6								
	17.0	5.1	11.8	1850	60.7	44.2	6.12	81.6	9.9	10.8								
120	8.5	0.9	2.1	1630	52.0	38.1	7.45	77.6	7.0	15.9								
	8.5	0.9	2.1	1850	52.9	41.0	7.72	79.2	6.8	16.2								
	12.8	2.7	6.2	1630	54.2	39.0	6.91	77.9	7.9	14.3								
	12.8	2.7	6.2	1850	55.2	41.9	7.16	79.6	7.7	14.6								
	17.0	5.0	11.5	1630	55.5	39.4	6.66	78.3	8.3	13.5								
	17.0	5.0	11.5	1850	56.4	42.4	6.90	80.0	8.2	13.8								

Interpolation is permissible, extrapolation is not. All performance data is based on the lower voltage of dual voltage units.  
 Performance stated is at the rated power supply, performance may vary as the power supply varies from the rated.  
 Table is with entering air of 80°F DB and 67°F WB in cooling, and 70°F DB in heating.  
 AHRI/ISO certified conditions are 80.6°F DB and 66.2°F WB in cooling and 68°F DB in heating.

Table does not reflect fan or pump power corrections for AHRI/ISO conditions.  
 See performance correction tables for operating conditions other than those listed above. See performance data selection notes for operation in the shaded areas.  
 Operation below 40°F EWT is based on a 15% methanol antifreeze solution.  
 Operation below 60°F EWT requires optional extended range insulated water and refrigerant circuits to avoid condensation within the unit cabinet.



Model	026	038	049	064	072
Compressor (1 Each)	Copeland UltraTech Two-Stage Scroll				
Factory Charge HFC-410a, oz [kg]	44 [1.25]	52 [1.47]	69 [1.96]	142 [4.03]	140 [3.97]
<b>ECM Motor &amp; Blower</b>					
Fan Motor, hp [W]	1/2 [373]	1/2 [373]	1 [746]	1 [746]	1 [746]
Blower Wheel Size (Dia x W), in [mm]	9 x 7 [229 x 178]	11 x 10 [279 x 254]	11 x 10 [279 x 254]	11 x 10 [279 x 254]	11 x 10 [279 x 254]
<b>Water Connection Size</b>					
Swivel - Residential Class	1"	1"	1"	1"	1"
<b>HWG Water Connection Size</b>					
Swivel - Residential Class	1"	1"	1"	1"	1"
<b>Vertical Upflow</b>					
Air Coil Dimensions (H x W), in [mm]	28 x 20 [711 x 542]	28 x 25 [711 x 635]	32 x 25 [813 x 635]	36 x 25 [914 x 635]	36 x 25 [914 x 635]
Standard Filter - 2" [51mm] Pleated MERV11 Throwaway, in [mm]	28 x 24 [712 x 610]	28 x 29.5 [712 x 749]	32 x 29.5 [813 x 749]	36 x 29.5 [914 x 749]	36 x 29.5 [914 x 749]
Weight - Operating, lbs [kg]	298 [135]	359 [163]	448 [203]	475 [215]	475 [215]
Weight - Packaged, lbs [kg]	308 [140]	369 [167]	458 [208]	485 [220]	485 [220]
<b>Horizontal</b>					
Air Coil Dimensions (H x W), in [mm]	18 x 31 [457 x 787]	20 x 35 [508 x 889]	20 x 40 [508 x 1018]	20 x 45 [508 x 1143]	20 x 45 [508 x 1143]
Standard Filter - 2" [51mm] Pleated MERV11 Throwaway, in [mm]	2 - 18 x 18 [457 x 457]	1 - 12 x 20 [305 x 508] 1 - 20 x 25 [508 x 635]	1 - 18 x 20 [457 x 508] 1 - 20 x 24 [508 x 610]	2 - 20 x 24 [508 x 610]	2 - 20 x 24 [508 x 610]
Weight - Operating, lbs [kg]	298 [135]	359 [163]	448 [203]	475 [215]	475 [215]
Weight - Packaged, lbs [kg]	308 [140]	369 [167]	458 [208]	485 [220]	485 [220]

All units have grommet compressor mountings, TXV expansion devices, and 1/2" [12.7mm] & 3/4" [19.1mm] electrical knockouts.

Unit Maximum Working Water Pressure	
Options	Max Pressure PSIG (kPa)
Base Unit	500 (3,447)
Unit with Internal Flow Controller	145 (999)
Unit with Internal Modulating Water Valve	300 (2,068)
Unit with ClimaDry	145 (999)

# Dimensions — Vertical Upflow Tranquility® 30

**Legend**  
 CAP=Control Access Panel  
 CSP=Compressor Service Panel  
 BSP=Blower Service Panel  
 ASP=Alternate Service Panel

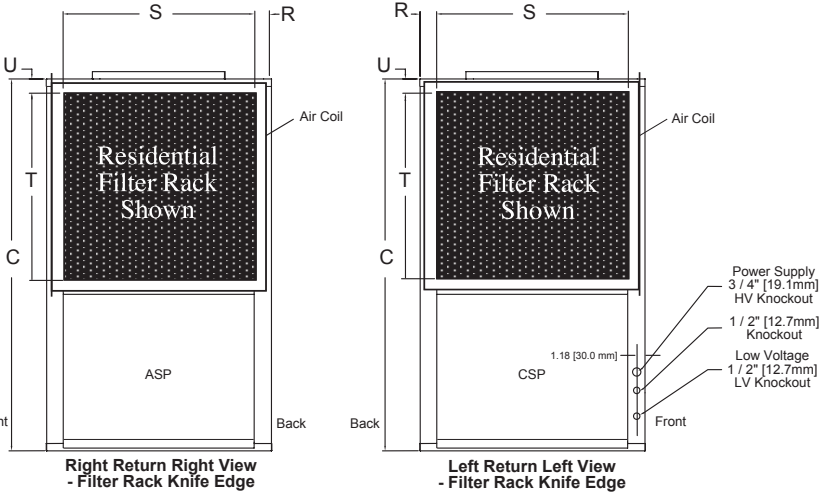
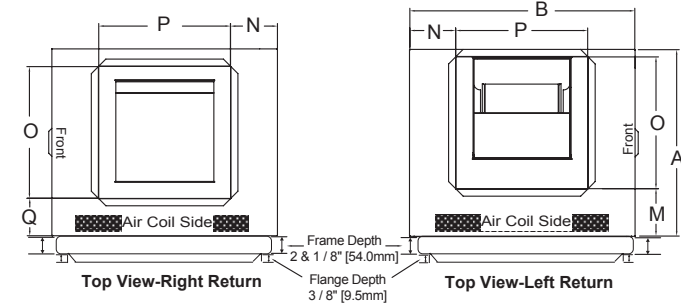
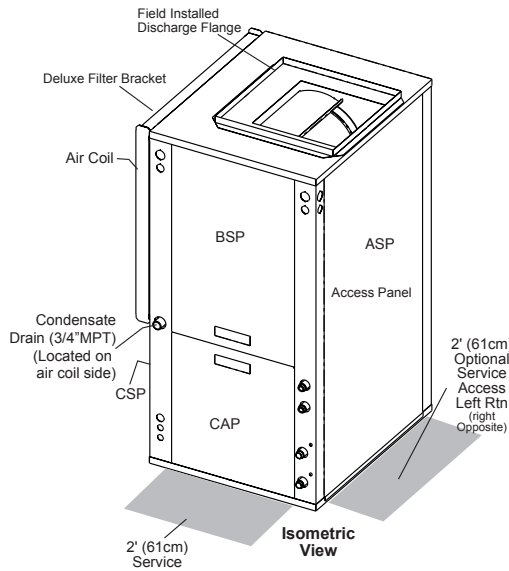

Vertical Upflow Model	Overall Cabinet			
	A Width	B Depth	C Height	
TE026	in cm	22.4 56.8	25.6 65.1	48.5 123.2
TE038	in cm	25.4 64.5	30.6 77.8	50.5 128.3
TE049	in cm	25.4 64.5	30.6 77.8	54.5 138.4
TE064	in cm	25.4 64.5	30.6 77.8	58.5 148.6
TE072	in cm	25.4 64.5	30.6 77.8	58.5 148.6

Vertical Upflow Model	Discharge Connection Duct Flange Installed (+/- 0.20 in, +/- 5.1mm)					Return Connection Standard Deluxe Filter Rack (+/- 0.20 in, +/- 5.1mm)				
	M Left Return	N	O Supply Width	P Supply Depth	Q Right Return	R	S Return Depth	T Return Height	U	
026	in cm	7.8 18.3	5.8 14.8	14.0 35.6	14.0 35.6	4.9 12.4	1.7 4.3	22.2 56.4	26.2 66.5	1.7 4.3
038	in cm	6.4 16.1	6.3 16.0	18.0 45.7	18.0 45.7	5.3 13.5	1.7 4.3	27.2 69.1	26.2 66.5	1.7 4.3
049	in cm	6.4 16.1	6.3 16.0	18.0 45.7	18.0 45.7	5.3 13.5	1.7 4.3	27.2 69.1	30.2 76.7	1.7 4.3
064	in cm	6.4 16.1	6.3 16.0	18.0 45.7	18.0 45.7	5.3 13.5	1.7 4.3	27.2 69.1	34.2 86.9	1.7 4.3
072	in cm	6.4 16.1	6.3 16.0	18.0 45.7	18.0 45.7	5.3 13.5	1.7 4.3	27.2 69.1	34.2 86.9	1.7 4.3

## Dimensions — Vertical Upflow Tranquility® 30

Vertical Upflow Model		Water Connections							Loop Water FPT	HWG FPT	Cond. Drain
		D	E	F	G	H					
		Loop In	Loop Out	Condensate	HWG In	HWG Out					
026	in cm	3.9 9.9	8.4 21.3	19.9 50.5	14.6 37.1	17.0 43.2	1" Swivel	1" Swivel	3/4" MPT		
038	in cm	3.9 9.9	8.4 21.3	21.8 55.4	15.4 39.1	18.7 47.5	1" Swivel	1" Swivel	3/4" MPT		
049	in cm	3.9 9.9	8.4 21.3	21.8 55.4	15.4 39.1	18.7 47.5	1" Swivel	1" Swivel	3/4" MPT		
064	in cm	3.9 9.9	8.4 21.3	21.8 55.4	15.4 39.1	18.7 47.5	1" Swivel	1" Swivel	3/4" MPT		
072	in cm	3.9 9.9	8.4 21.3	21.8 55.4	15.4 39.1	18.7 47.5	1" Swivel	1" Swivel	3/4" MPT		

Vertical Upflow Model		Electrical Knockouts		
		J 1/2"	K 1/2"	L 3/4"
		Low Voltage	External Pump	Power Supply
026	in	4.4	5.9	7.4
- 072	cm	11.2	15.0	18.8

Condensate connection is 3/4" MPT and is located on the air coil side of the front of the unit.  
 Unit shipped with deluxe duct collar/filter rack extending from unit 3" [7.6cm] and is suitable for duct connection.  
 Discharge flange is field installed.

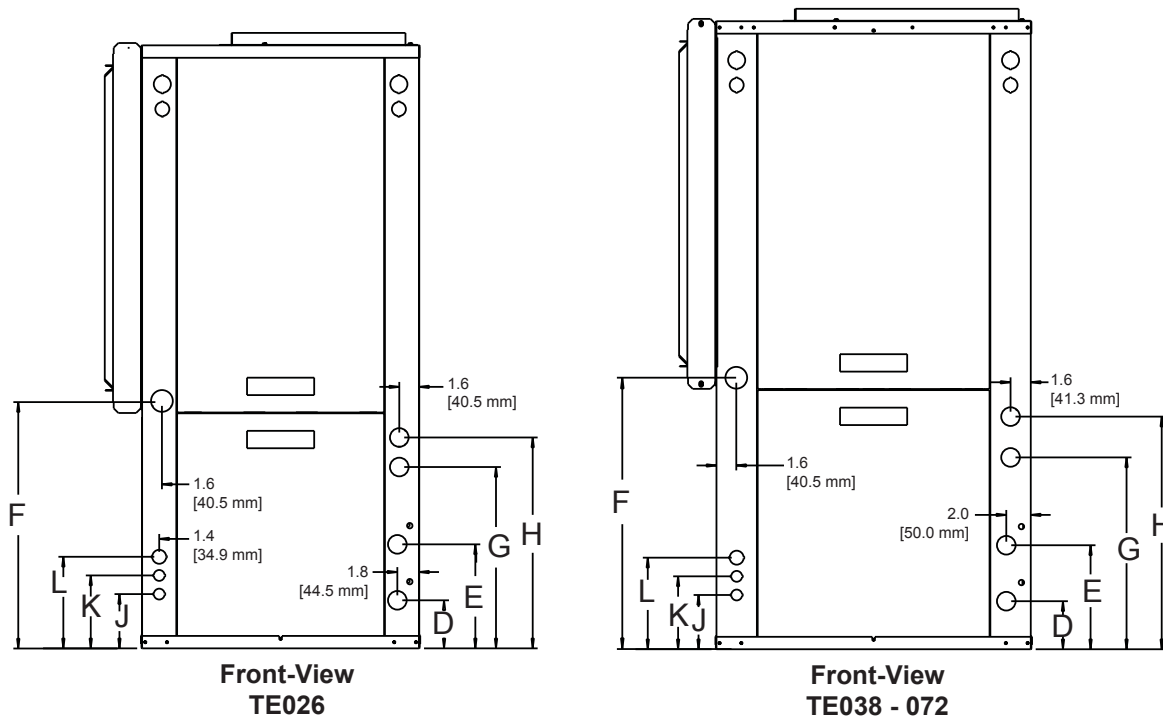

# Dimensions — Vertical Downflow Tranquility® 30

**Legend**  
 CAP=Control Access Panel  
 CSP=Compressor Service Panel  
 BSP=Blower Service Panel  
 ASP=Alternate Service Panel

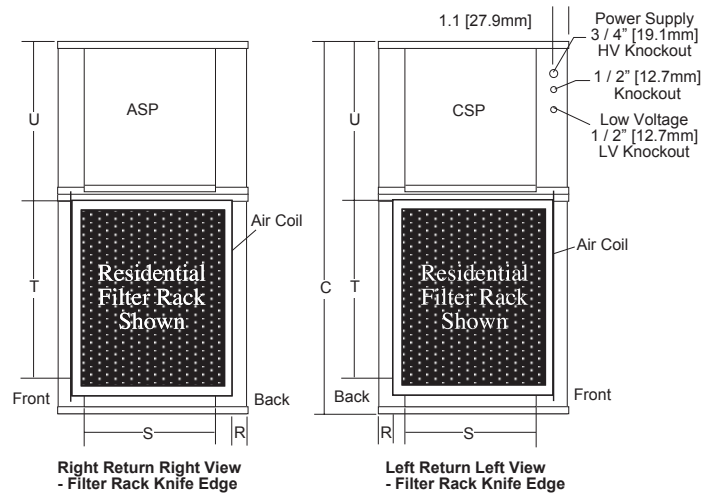
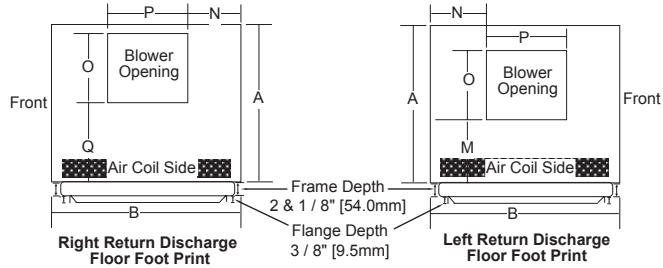
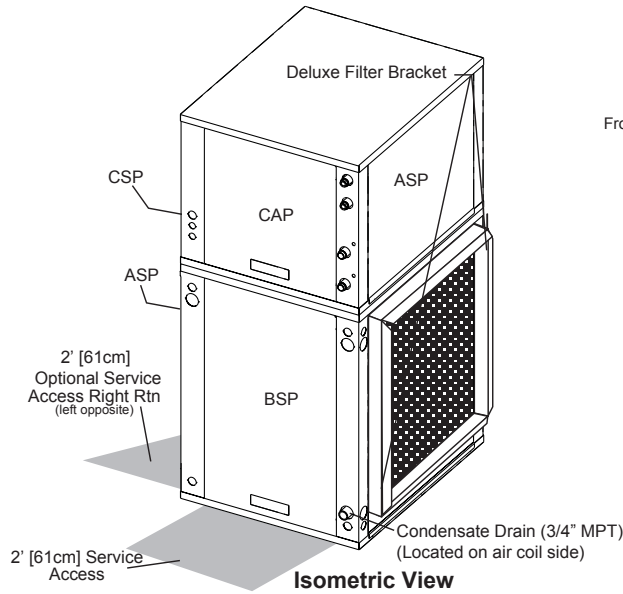

Vertical Downflow Model	Overall Cabinet		
	A Width	B Depth	C Height
TE026	in 22.4	25.6	52.5
	cm 56.8	65.1	133.4
TE038	in 25.4	30.6	54.5
	cm 64.5	77.8	138.4
TE049	in 25.4	30.6	58.5
	cm 64.5	77.8	148.6
TE064	in 25.4	30.6	62.5
	cm 64.5	77.8	158.8
TE072	in 25.4	30.6	62.5
	cm 64.5	77.8	158.8

Vertical Downflow Model	Discharge Connection Duct Flange Installed (+/- 0.20 in, +/- 5.1mm)					Return Connection Standard Deluxe Filter Rack (+/- 0.20 in, +/- 5.1mm)				
	M Left Return	N	O Supply Width	P Supply Depth	Q Right Return	R	S Return Depth	T Return Height	U	
026	in 6.7	8.4	9.9	9.1	10.8	1.7	22.2	26.2	21.9	
	cm 17.1	21.4	25.3	23.0	27.4	4.3	56.4	66.5	55.6	
038	in 7.4	9.0	13.1	12.9	10.4	1.7	27.2	26.2	23.9	
	cm 18.7	22.9	33.3	32.7	26.5	4.3	69.1	66.5	60.7	
049	in 7.4	9.0	13.1	12.9	10.4	1.7	27.2	30.2	23.9	
	cm 18.7	22.9	33.3	32.7	26.5	4.3	69.1	76.7	60.7	
064	in 7.4	9.0	13.1	12.9	10.4	1.7	27.2	34.2	23.9	
	cm 18.7	22.9	33.3	32.7	26.5	4.3	69.1	86.9	60.7	
072	in 7.4	9.0	13.1	12.9	10.4	1.7	27.2	34.2	23.9	
	cm 18.7	22.9	33.3	32.7	26.5	4.3	69.1	86.9	60.7	

## Dimensions — Vertical Downflow Tranquility® 30

Vertical Downflow Model		Water Connections							
		D	E	F	G	H	Loop Water FPT	HWG FPT	Cond. Drain
		In	Out	Condensate	HWG In	HWG Out			
026	in cm	15.4 39.1	10.9 27.7	4.7 11.9	4.7 11.9	2.3 5.8	1" Swivel	1" Swivel	3/4" MPT
038	in cm	17.4 44.2	12.9 32.8	4.7 11.9	5.8 14.7	2.5 6.4	1" Swivel	1" Swivel	3/4" MPT
049	in cm	17.4 44.2	12.9 32.8	4.7 11.9	5.8 14.7	2.5 6.4	1" Swivel	1" Swivel	3/4" MPT
064	in cm	17.4 44.2	12.9 32.8	4.7 11.9	5.8 14.7	2.5 6.4	1" Swivel	1" Swivel	3/4" MPT
072	in cm	17.4 44.2	12.9 32.8	4.7 11.9	5.8 14.7	2.5 6.4	1" Swivel	1" Swivel	3/4" MPT

Vertical Upflow Model		Electrical Knockouts		
		J 1/2"	K 1/2"	L 3/4"
		Low Voltage	External Pump	Power Supply
026	in cm	14.9 37.8	13.4 34.0	11.9 30.2
038 - 049	in cm	16.9 42.9	15.3 38.9	13.9 35.3

Condensate connection is 3/4" MPT and is located on the air coil side of the front of the unit.  
 Unit shipped with deluxe duct collar/filter rack extending from unit 3" [7.6cm] and is suitable for duct connection.  
 Downflow unit does not have discharge flange, and is rated for zero clearance installation.

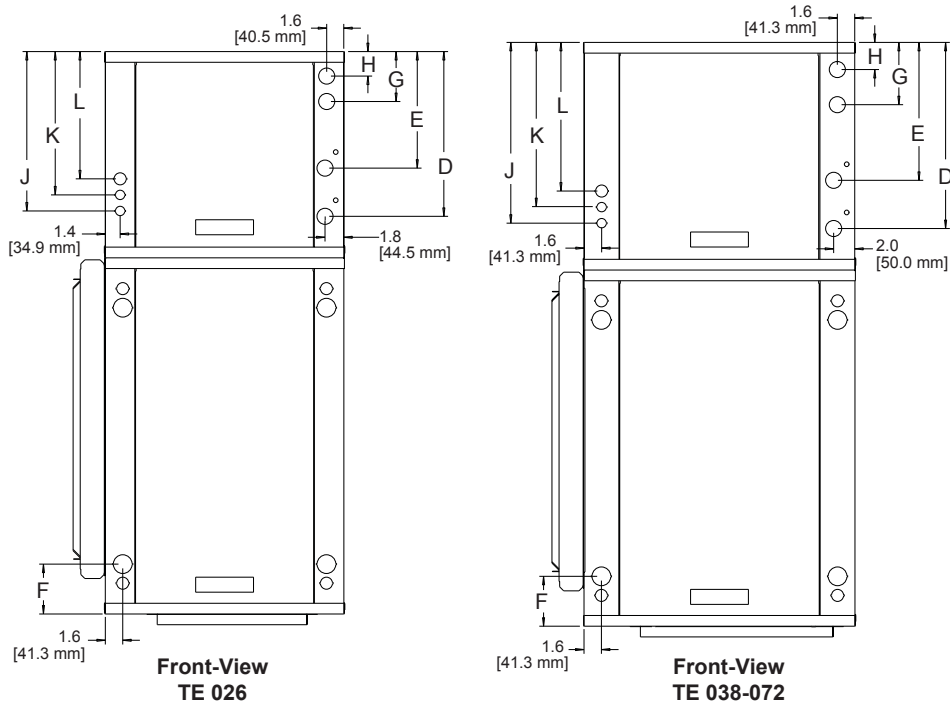



# Dimensions — Horizontal Tranquility® 30

**Legend**  
 CAP=Control Access Panel  
 CSP=Compressor Service Panel  
 BSP=Blower Service Panel  
 ASP=Alternate Service Panel

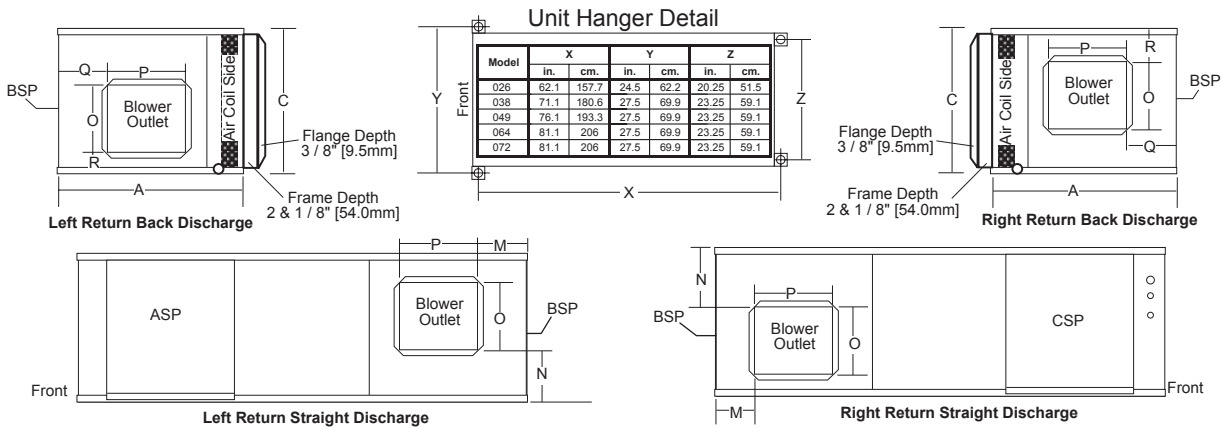

Horizontal Model		Overall Cabinet		
		A Width	B Depth	C Height
TE026	in	22.4	62.2	19.3
	cm	56.8	158.0	48.9
TE038	in	25.4	71.2	21.3
	cm	64.5	180.8	54.0
TE049	in	25.4	76.2	21.3
	cm	64.5	193.5	54.0
TE064	in	25.4	81.2	21.3
	cm	64.5	206.2	54.0
TE072	in	25.4	81.2	21.3
	cm	64.5	206.2	54.0

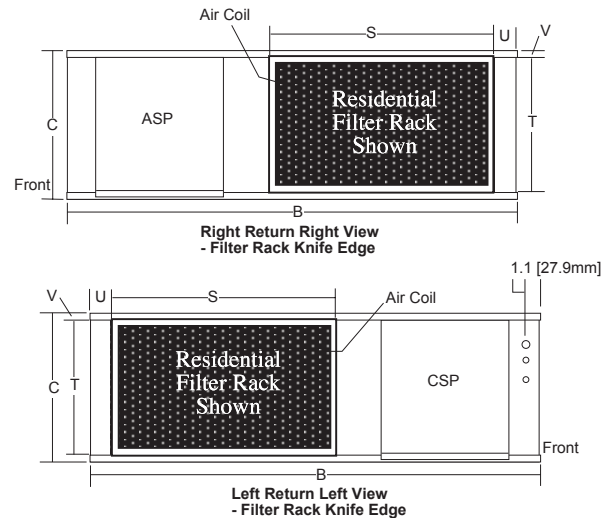

Horizontal Model		1Discharge Connection Duct Flange Installed (+/- 0.20 in, +/- 5.1mm)						Return Connection Standard Deluxe Filter Rack (+/- 0.20 in, +/- 5.1mm)			
		M	N	O Supply Height	P Supply Width	Q	R	S Return Width	T Return Height	U	V
026	in	3.6	2.0	15.5	12.5	3.6	2.0	33.8	16.2	2.3	1.7
	cm	9.3	5.1	39.4	31.8	9.2	5.2	85.8	41.0	5.8	4.3
038	in	*3.1	1.2	19.0	17.5	*3.1	1.0	34.8	18.2	3.1	1.7
	cm	7.9	3.1	48.3	44.5	7.9	2.6	88.3	46.1	7.8	4.3
049	in	3.1	1.2	19.0	17.5	3.1	1.0	39.8	18.2	3.1	1.7
	cm	7.9	3.1	48.3	44.5	7.9	2.6	101.0	46.1	7.8	4.3
064	in	3.1	1.2	19.0	17.5	3.1	1.0	44.8	18.2	3.1	1.7
	cm	7.9	3.1	48.3	44.5	7.9	2.6	113.7	46.1	7.8	4.3
072	in	3.1	1.2	19.0	17.5	3.1	1.0	44.8	18.2	3.1	1.7
	cm	7.9	3.1	48.3	44.5	7.9	2.6	113.7	46.1	7.8	4.3

\*For units with modulating reheat option this dimension is 2.9" (7.4 cm).

1Discharge connection will change when using the accessory auxiliary electric heat package. Refer to the heater IOM for details.

## Dimensions — Horizontal Tranquility® 30

**Legend**  
 CAP=Control Access Panel  
 CSP=Compressor Service Panel  
 BSP=Blower Service Panel  
 ASP=Alternate Service Panel

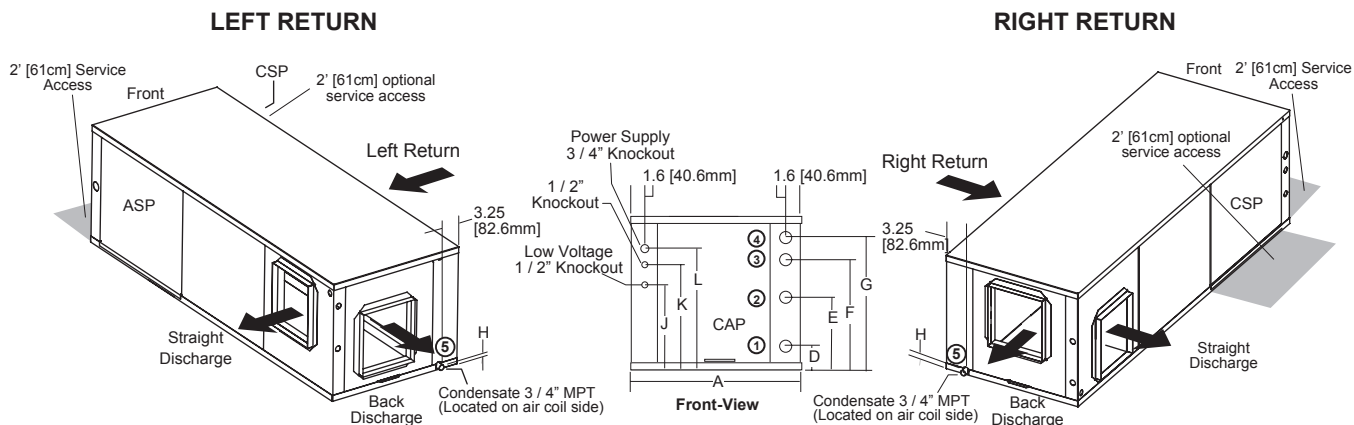

Horizontal Model		Water Connections							
		D	E	F	G	H	Loop Water FPT	HWG FPT	Cond. Drain
		In	Out	HWG IN	HWG Out	Condensate			
026	in cm	3.9 9.9	8.4 21.3	19.9 50.5	14.6 37.1	0.6 1.5	1" Swivel	1" Swivel	3/4" MPT
038	in cm	3.9 9.9	8.4 21.3	21.8 55.4	15.4 39.1	0.6 1.5	1" Swivel	1" Swivel	3/4" MPT
049	in cm	3.9 9.9	8.4 21.3	21.8 55.4	15.4 39.1	0.6 1.5	1" Swivel	1" Swivel	3/4" MPT
064	in cm	3.9 9.9	8.4 21.3	21.8 55.4	15.4 39.1	0.6 1.5	1" Swivel	1" Swivel	3/4" MPT
072	in cm	3.9 9.9	8.4 21.3	21.8 55.4	15.4 39.1	0.6 1.5	1" Swivel	1" Swivel	3/4" MPT

Horizontal Model		Electrical Knockouts		
		J 1/2"	K 1/2"	L 3/4"
		Low Voltage	External Pump	Power Supply
026	in	4.4	5.9	7.4
- 072	cm	11.2	15.0	18.8

Condensate is 3/4" MPT.  
 Unit shipped with deluxe duct collar/filter rack extending from unit 3" [7.6cm] and is suitable for duct connection.  
 Discharge flange and hanger brackets are factory installed.

## Electrical Data

### With Internal Flow Controller - High Head

Model	Compressor			HWG Pump FLA	Loop Pump FLA	Fan Motor FLA	Total Unit FLA	Min Circuit Amps	Max/ Fuse HACR
	RLA	LRA	Qty						
026	11.7	58.3	1	0.5	1.44	3.9	17.5	20.4	30
038	15.3	83.0	1	0.5	1.44	3.9	21.1	24.9	40
049	21.2	104.0	1	0.5	1.44	6.9	30.0	35.3	50
064	27.1	152.9	1	0.5	1.44	6.9	35.9	42.7	70
072	29.7	179.2	1	0.5	1.44	6.9	38.5	45.9	70

Rated Voltage of 208/230/60/1

Min/Max Voltage of 197/254  
All fuses Class RK-5

### With Internal Flow Controller - Standard Head

Model	Compressor			HWG Pump FLA	Loop Pump FLA	Fan Motor FLA	Total Unit FLA	Min Circuit Amps	Max/ Fuse HACR
	RLA	LRA	Qty						
026	11.7	58.3	1	0.5	0.7	3.9	16.8	19.7	30
038	15.3	83.0	1	0.5	0.7	3.9	20.4	24.2	35

Rated Voltage of 208/230/60/1

Min/Max Voltage of 197/254  
All fuses Class RK-5

### Without Flow Controller

Model	Compressor			HWG Pump FLA	External Loop Pump FLA	Fan Motor FLA	Total Unit FLA	Min Circuit Amps	Max/ Fuse HACR
	RLA	LRA	Qty						
026	11.7	58.3	1	0.5	4.0	3.9	20.1	23.0	30
038	15.3	83.0	1	0.5	4.0	3.9	23.7	27.5	40
049	21.2	104.0	1	0.5	4.0	6.9	32.6	37.9	50
064	27.1	152.9	1	0.5	4.0	6.9	38.5	45.2	70
072	29.7	179.2	1	0.5	4.0	6.9	41.1	48.5	70

Rated Voltage of 208/230/60/1

Min/Max Voltage of 197/254  
All fuses Class RK-5









## ECM Blower Control

The ECM fan is controlled directly by the DXM2.5 control board that converts thermostat inputs and CFM settings to signals used by the ECM motor controller. To take full advantage of the ECM motor features, a communicating multi-stage thermostat should be used (AWC99U\*\*).

The DXM2.5 control maintains a selectable operating airflow [CFM] for each heat pump operating mode. For each operating mode there are maximum and minimum airflow limits. See the ECM Blower Performance tables for the maximum, minimum, and default operating airflows.

Airflow levels are selected using the configuration menus of a communicating thermostat (AWC99U\*\*) or diagnostic tool (ACDU\*\*). The configuration menus allow the installer to independently select and adjust the operating airflow for each of the operating modes. Air flow can be selected in 25 CFM increments within the minimum and maximum limits shown in the ECM Blower Performance Table. The blower operating modes include:

- First Stage Cooling (Y1 & O)
- Second Stage Cooling (Y1, Y2, & O)
- First Stage Cooling in Dehumidification Mode (Y1, O, & Dehumid)
- Second Stage Cooling in Dehumidification Mode (Y1, Y2, O, & Dehumid)
- First Stage Heating (Y1)
- Second Stage Heating (Y1 & Y2)
- Third Stage (Auxiliary) Heating (Y1, Y2, & W)
- Emergency Heating (W with no Y1 or Y2)
- Fan (G with no Y1, Y2, or W)

It is highly recommended that AWC99U\*\* or ACDU\*\* be used to set dehumidification mode electronically. Dehumidification can NOT be selected when using a non-communicating thermostat with a vFlow® unit with Internal Flow Controller (pump). For dehumidification settings on other units using the non-communicating stat, refer to DXM2.5 AOM (part #97B0003N15).

The ECM motor includes “soft start” and “ramp down” features. The soft start feature is a gentle increase of motor rpm at blower start up. This creates a much quieter blower start cycle.

The ramp down feature allows the blower to slowly decrease rpm to a full stop at the end of each blower cycle. This creates a much quieter end to each blower cycle and adds overall unit efficiency.

The ramp down feature is eliminated during an ESD (Emergency Shut Down) situation. When the DXM2.5 ESD input is activated, the blower and all other control outputs are immediately de-activated.

The ramp down feature (also known as the heating or cooling “Off Delay”) is field selectable by the installer. The allowable range is 0 to 255 seconds.

### Airflow Configuration Screen on Communicating Thermostat

AIRFLOW SELECTION	
	CFM
HEAT STAGE 1	600
HEAT STAGE 2	750
AUXILIARY HEAT	850
EMERGENCY HEAT	850
COOL STAGE 1	525
COOL STAGE 2	700
COOL DEHUMID 1	425
COOL DEHUMID 2	550
CONTINUOUS FAN	350
HEAT OFF DELAY	60
COOL OFF DELAY	30
◀ PREVIOUS	NEXT ▶

## Blower Performance Data

Airflow in CFM with wet coil and clean air filter

Model	Max ESP (in. wg)	Fan Motor (hp)	Range	Cooling Mode		Dehumid Mode		Heating Mode		Fan Only Mode	Aux/ Emerg Mode
				Stg 2	Stg 1	Stg 2	Stg 1	Stg 2	Stg 1		
026	1.0	1/2	Default	700	525	550	425	750	600	350	850
			Maximum	1000	800	800	600	1000	850	1000	1000
			Minimum	600	450	550	400	600	450	300	700
038	0.9	1/2	Default	1050	800	850	650	1100	850	550	1350
			Maximum	1500	1100	1200	900	1500	1100	1500	1500
			Minimum	900	600	825	550	900	600	450	1350
049	1.0	1	Default	1400	1050	1100	850	1500	1150	700	1500
			Maximum	2000	1500	1600	1200	2000	1500	2000	2000
			Minimum	1200	900	1100	825	1200	900	600	1350
064	0.7	1	Default	1750	1300	1400	1050	1875	1450	875	1875
			Maximum	2300	1900	2000	1500	2300	1900	2300	2300
			Minimum	1500	1100	1375	1000	1500	1100	750	1500
072	0.7	1	Default	1900	1450	1650	1250	2000	1650	950	2000
			Maximum	2300	2200	2000	1800	2300	2200	2300	2300
			Minimum	1800	1350	1650	1250	1800	1350	900	1800

Airflow is controlled within 5% up to the Max ESP shown with wet coil

## ClimaDry® – Benefits and Application

### ClimaDry® Modulating Reheat

ClimateMaster's patented ClimaDry® Dehumidification is an innovative means of providing modulating reheat without the complication of refrigeration controls. ClimaDry is hot gas generated reheat, which utilizes one of the biggest advantages of a Water-Source Heat Pump (WSHP), the transfer of energy through the water piping system. ClimaDry simply diverts condenser water through a water-to-air coil that is placed after the evaporator coil. If condenser water is not warm enough, the internal "run-around" loop increases the water temperature with each pass through the condenser coil (see figure 1, below).

### ClimaDry® Benefits

ClimaDry® is like no other reheat option on the market. Proportional reheat is controlled to the desired leaving air temperature setpoint (factory setpoint of 72°F, 22°C), no matter what the water loop temperature is. Since dehumidification operation will occur under less than full load cooling conditions a good percentage of the time, it is important to have a reheat function that provides 100% reheat in the spring and fall when the water loop is cool. Competitors without ClimaDry® typically use an on/off (non-modulating) refrigeration based reheat circuit, typically referred to as "Hot gas reheat" (HGR). HGR needs higher condensing temperatures to work well, typically 85°F [29°C] entering water temperature (EWT).

With HGR, cooler water temperatures produce cooler supply air temperatures, which could overcool the space, requiring additional space heating from another source or a special auto-change-over relay to allow the unit to switch back and forth between reheat and heating. Rarely does HGR provide 100% reheat, like ClimaDry. ClimaDry has a simple and easy to troubleshoot refrigerant circuit. No switching valves or hard to diagnose leaky check valves are utilized. No unusual refrigerant pressures occur during the reheat mode. The ClimaDry refrigerant circuit is like every other ClimateMaster unit (without reheat), so everything the technician already knows applies to troubleshooting the ClimaDry refrigeration circuit. Plus, the water loop portion of the ClimaDry option is easy to understand and diagnose.

### ClimaDry® Applications

ClimaDry® can be applied to a number of common applications, such as:

- Classrooms.
- Condominiums.
- Apartments.
- Computer rooms.
- Spaces with high latent loads like auditoriums, theaters, convention centers, etc.
- Most applications where humidity is a problem.  
(Note: ClimaDry® is not for use in high fraction outdoor air applications or in applications with corrosive atmospheres, such as pool rooms.)

With the ClimaDry®, return air from the space is cooled by the air-to-refrigerant (evaporator) coil, and then reheated by the water-to-air (reheat) coil to dehumidify the air, but maintain the same space temperature (thus operating as a dehumidifier).

Figure 1: ClimaDry® Schematic

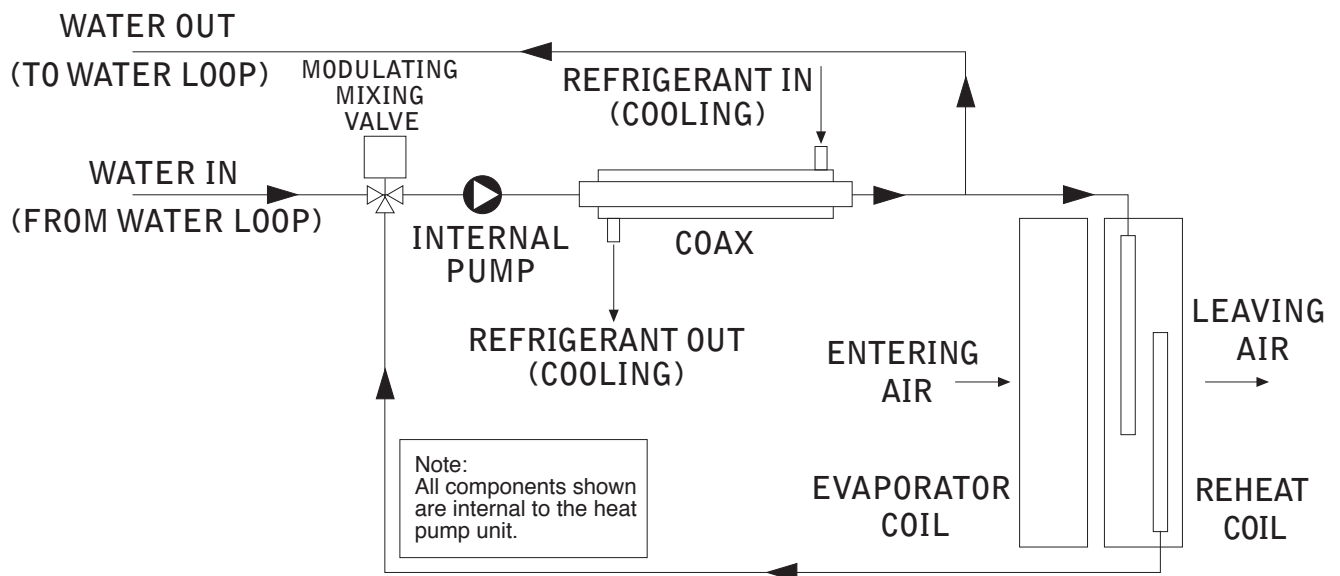

## ClimaDry® – Benefits and Application

The moisture removal capability of the heat pump is determined by the unit's latent capacity rating. Latent capacity equals Total capacity minus Sensible capacity. Using unit performance data from submittals (climatemaster.com) select the correct model, use your maximum entering water temperature (EWT) and flow rate to select TC and SC. For example, at 80° F [26.7° C] EWT and 6.8 GPM, the moisture removal capability (latent capacity) of a ClimateMaster unit is 11.8 Mbtuh [3.5 kW] as shown below.

Dividing the latent capacity by 1,069 BTU/LB of water vapor at 80° F DB and 67° F WB [26.7° C DB and 19.4° C WB] moist air enthalpy, converts the amount of moisture removal to pounds per hour (multiply pounds per hour by 0.4536 to obtain kg/hr). Calculations are shown below.

Most ClimateMaster water source heat pumps have a sensible-to-total (S/T) ratio of 0.72 to 0.82. Therefore, approximately, 25% of the cooling capacity is dedicated to latent cooling capacity (moisture removal). When selecting a unit with ClimaDry, the space sensible and latent loads should be calculated. If the unit will be used for space cooling, a unit with at least enough capacity to satisfy the building sensible load should be selected. If the latent cooling load is not satisfied by the selection, a larger unit with enough latent capacity will be required. If the unit will be used for dehumidification purposes only, the latent capacity is the only consideration necessary. In this case, sensible load is immaterial.

$$LC = TC - SC = 37.2 - 25.4 = 11.8 \text{ Mbtuh}$$

$$11,800 \text{ Btuh} \div 1069 = 11.0 \text{ lbs/hr}$$

### Example Performance

EWT °F	GPM	WPD		Cooling - EAT 80/67°F							Heating - EAT 70°F					
		PSI	FT	Airflow CFM	TC	SC	Sens/ Total Ratio	kW	HR	EER	Airflow CFM	HC	kW	HE	LAT	COP
70	4.5	1.1	2.5	1080	37.8	25.7	0.68	2.22	45.3	17.0	1080	44.0	2.71	34.8	107.7	4.75
	4.5	1.1	2.5	1250	38.7	28.2	0.73	2.32	46.6	16.7	1250	44.8	2.60	36.0	103.2	5.05
	6.8	2.9	6.7	1080	39.1	26.2	0.67	2.08	46.1	18.8	1080	46.4	2.79	36.9	109.8	4.88
	6.8	2.9	6.7	1250	40.0	28.8	0.72	2.17	47.4	18.4	1250	47.3	2.67	38.2	105.0	5.19
80	4.5	1.0	2.3	1080	35.8	24.8	0.69	2.44	44.2	14.7	1080	48.3	2.84	38.6	111.4	4.98
	4.5	1.0	2.3	1250	36.7	27.2	0.74	2.55	45.4	14.4	1250	49.2	2.73	39.9	106.5	5.29
	6.8	2.8	6.6	1080	37.2	25.4	0.68	2.29	45.0	16.3	1080	51.1	2.93	41.1	113.8	5.10
	6.8	2.8	6.6	1250	38.0	27.9	0.73	2.39	46.2	15.9	1250	52.1	2.81	42.5	108.6	5.43
85	4.5	1.0	2.2	1080	34.8	24.3	0.70	2.57	43.6	13.6	1080	50.5	2.92	40.6	113.3	5.08
	4.5	1.0	2.2	1250	35.6	26.7	0.75	2.68	44.8	13.3	1250	51.5	2.80	41.9	108.1	5.40
	6.8	2.8	6.4	1080	36.2	25.0	0.69	2.40	44.4	15.0	1080	53.5	3.02	43.2	115.9	5.20
	6.8	2.8	6.4	1250	37.0	27.4	0.74	2.51	45.6	14.7	1250	54.5	2.89	44.7	110.4	5.53
90	4.5	0.9	2.1	1080	33.8	23.9	0.71	2.70	43.0	12.5	1080	52.7	2.99	42.5	115.2	5.17
	4.5	0.9	2.1	1250	34.6	26.2	0.76	2.81	44.2	12.3	1250	53.7	2.86	44.0	109.8	5.50
	6.8	2.7	6.2	1080	35.1	24.5	0.70	2.52	43.8	13.9	1080	55.9	3.10	45.3	117.9	5.29
	6.8	2.7	6.2	1250	36.0	26.9	0.75	2.63	45.0	13.7	1250	57.0	2.97	46.9	112.2	5.62

Dividing the latent capacity by 1,069 BTU/LB of water vapor at 80° F DB and 67° F WB [26.7° C DB and 19.4° C WB] moist air enthalpy, converts the amount of moisture removal to pounds per hour (multiply pounds per hour by 0.4536 to obtain kg/hr).



## ClimaDry® – Sequence of Operation

### ClimaDry® Sequence of Operation

A heat pump equipped with ClimaDry® can operate in three modes; cooling, cooling with reheat (dehumidification), and heating. The cooling/heating modes are like any other ClimateMaster WSHP. The reversing valve (“O” signal) is energized in cooling, along with the compressor contactor(s) and blower relay. In the heating mode the reversing valve is de-energized. Almost any thermostat will activate the heat pump in heating or cooling modes. The DXM2 microprocessor board, which is required with the ClimaDry option, will accept either heat pump (Y,O) thermostats or non-heat pump (Y,W) thermostats. The reheat mode requires either a separate humidistat/dehumidistat or a thermostat that has an integrated dehumidification function for activation. The DXM2 board is configured to work with either a humidistat or dehumidistat input to terminal “H”. Upon receiving an “H” input, the DXM2 board will activate the cooling mode and engage reheat. There are four operational inputs for single stage units and six operational inputs for dual stage units:

- Fan Only
- 1st Stage Cooling
- 2nd Stage Cooling
- 1st Stage Heating
- 2nd Stage Heating
- Reheat Mode

**Fan Only:** A (G) call from the thermostat to the (G) terminal of the DXM2 control board will bring the unit on in fan only mode.  
**1st Stage Heating:** A simultaneous call from (G) and (Y1) to the (G) and (Y1) terminals of the DXM2 control board will bring the unit on in 1st Stage Heating.

**1st Stage Cooling:** A simultaneous call from (G), (Y1), (Y2), and (O) to the (G), (Y1), (Y2), (O/W2) terminals of the DXM2 control board will bring the unit on in 2nd Stage Cooling. When the call is satisfied at the thermostat, the unit will continue to run in the 1st Stage Cooling until the 1st Stage Cooling call is removed or satisfied, shutting down the unit.

**2nd Stage Cooling:** A simultaneous call from (G), (Y1), and (O) to the (G), (Y1), (O/W2) terminals of the DXM2 control board will bring the unit on in 1st Stage Cooling.

**1st Stage Heating:** A simultaneous call from (G) and (Y1) to the (G) and (Y1) terminals of the DXM2 control board will bring the unit on in 1st stage Heating.

**2nd Stage Heating:** A simultaneous call from (G), (Y1), and (Y2) to the (G), (Y1), and (Y2) terminals of the DXM2 control board will bring the unit on in 2nd Stage Heating. When the call is satisfied at the thermostat the unit will continue to run in 1st Stage Heating until the call is removed or satisfied, shutting down the unit. **NOTE: Not all units have two-stage heating functionality.**

Table 2: Humidistat/Dehumidistat Logic and DXM2.5 (2.1, 2.2., 2.3) DIP Settings

Sensor	2.1	2.2	2.3	Logic	Reheat (ON) - H	Reheat (OFF) - H
Humidistat	OFF	OFF	OFF	Reverse	0 VAC	24 VAC
Dehumidistat	OFF	ON	OFF	Standard	24 VAC	0 VAC

Table 3: ClimaDry® Operating Modes

Mode	Input					Output				
	O	G	Y1	Y2 <sup>3</sup>	H	O	G	Y1	Y2 <sup>3</sup>	Reheat
No Demand	ON/OFF	OFF	OFF	OFF	OFF	ON/OFF	OFF	OFF	OFF	OFF
Fan Only	ON/OFF	ON	OFF	OFF	OFF	ON/OFF	ON	OFF	OFF	OFF
Cooling 1st Stage	ON	ON	ON	OFF	OFF	ON	ON	ON	OFF	OFF
Cooling 2nd Stage	ON	ON	ON	ON	OFF	ON	ON	ON	ON	OFF
Cooling & Dehumidistat <sup>1</sup>	ON	ON	ON	ON/OFF	ON	ON	ON	ON	ON/OFF	OFF
Dehumidistat Only	ON/OFF	OFF	OFF	OFF	ON	ON	ON	ON	ON	ON
Heating 1st Stage	OFF	ON	ON	OFF	OFF	OFF	ON	ON	OFF	OFF
Heating 2nd Stage	OFF	ON	ON	ON	OFF	OFF	ON	ON	ON	OFF
Heating & Dehumidistat <sup>2</sup>	OFF	ON	ON	ON/OFF	ON	OFF	ON	ON	ON/OFF	OFF

<sup>1</sup> Cooling input takes priority over dehumidify input.

<sup>2</sup> DXM2.5 is programmed to ignore the H demand when the unit is in heating mode.

<sup>3</sup> N/A for single stage units; Full load operation for dual capacity units.

<sup>4</sup> ON/OFF = Either ON or OFF.

## ClimaDry® – Sequence of Operation

**Reheat Mode:** A call from the Humidistat/Dehumidistat to the (H) terminal of the DXM2 control board will bring the unit on in Reheat Mode if there is no call for cooling at the thermostat. When the Humidistat/Dehumidification call is removed or satisfied the unit will shut down. **NOTE: Cooling always overrides Reheat Mode.** In the Cooling mode, the unit cools and dehumidifies. If the cooling thermostat is satisfied but there is still a call for dehumidification, the unit will continue to operate in Reheat Mode.

**Note: Care must be taken when using a humidistat to operate ClimaDry®. When the DIP switch on the DXM2 controller is set for ‘humidistat’ it reverses the control logic so that an “open” control circuit initiates a ClimaDry run cycle. If a humidistat is not connected, or if a manual switch on the humidistat is set to “off”, ClimaDry will see the open circuit and call for dehumidification.**

#### ClimaDry® Component Functions

The ClimaDry® option consists of the following components:

Motorized Valve/Proportional Controller

Supply Air Sensor

Loop Pump

Hydronic Coil

Low Air Temperature Safety

The Proportional Controller operates on 24 VAC power supply and automatically adjusts the water valve based upon the Supply Air Sensor. The Supply Air Sensor senses supply air temperature at the blower inlet providing the input signal necessary for the proportional control to drive the motorized valve during the reheat mode of operation. The Motorized Valve is a proportional actuator/three-way valve combination used to divert the condenser water from the coax to the hydronic reheat coil during the reheat mode of operation. The proportional controller signals the motorized valve based on the supply air temperature of the supply air sensor.

The Loop Pump circulates condenser water through the hydronic reheat coil during the reheat mode of operation. In this application, the loop pump is only energized during the reheat mode of operation. The Hydronic Coil is utilized during the reheat mode of operation to reheat the air to the setpoint of the proportional controller. Condenser water is diverted by the motorized valve and pumped through the hydronic coil by the loop pump in proportion to the control setpoint. The amount of reheating is dependent on the setpoint and how far from setpoint the supply air temperature is. The factory setpoint is 72° F [22° C], generally considered “neutral” air.

#### ClimaDry® Application Considerations

The reheat coil adds a small amount of resistance to the air stream. Consult the submittal data or the Installation/Operation/Maintenance (I.O.M.) manual for the specific heat pump to review blower tables.

Unlike most hot gas reheat options, the ClimaDry® option will operate over a wide range of EWTs. Special flow regulation (water regulating valve) is not required for low EWT conditions.

Unit minimum entering air temperature while in the dehumidification, cooling, or continuous fan modes is **65°F DB/55°F WB**. Operation below this minimum may result in nuisance faults.

Water-source heat pumps with ClimaDry should not be used as make-up air units. These applications should use equipment specifically designed for make-up air.

## Accessories & Warranty

### Accessories & Options

#### **vFlow® Internal Variable Speed Water-flow Control**

ClimateMaster takes ease and speed of installation of geothermal heating and cooling systems to the next level with vFlow® variable water flow control. vFlow integrates water-flow control inside the unit AND matches the flow to the unit's operating requirements. Compared to conventional units that can just turn the water-flow on or off, Tranquility® 30 Digital varies the water-flow, which results in lower operating cost and longer system life. New 2-way communicating control (and communicating Pump / modulating valve) make vFlow a reality and is only available on ClimateMaster systems.

#### **Hot Water Generator**

The optional Hot Water Generator includes an insulated double wall vented heat reclaiming heat exchanger suitable for potable water. The heat exchanger coil and hot water circulating pump are factory mounted internal to the unit. The microprocessor Hot Water Generator control uses sensors to monitor the entering potable water temperature and the compressor discharge line temperature and allows the Hot Water Generator to operate any time conditions permit. The Hot Water Generator includes a pump sampling mode to sense the hot water storage temperature while the Hot Water Generator is inactive.

**SecureStart™ Module** can expand the life of the unit by reducing start up current and protecting the compressor from low-voltage conditions.

**Electrical Service Disconnect Switch** located on the unit front panel for ease of service.

#### **Thermostat (field installed)**

The AWC99U\*\* communicating thermostat is a programmable multi-stage auto-changeover electronic digital thermostat. The AWC offers up to 3 heating and 2 cooling stages with precise temperature control. The AWC is capable of controlling heating and cooling stages using a differential or proportional integral control algorithm. Multiple system temperatures and data can be displayed. The AWC is an integral component in system configuration and diagnostics.

#### **Auxiliary Heater (field installed)**

An optional, internal, field-installed electric heater provides supplemental and/or emergency heat capability when used with the three stage heating thermostat. (Heater is externally mounted on horizontal units).

#### **Hose Connection Kit (field installed)**

An accessory hose kit includes 10' of 150psi 1" rubber hose with brass fittings equipped with service pressure/temperature ports for connection between the unit and Flow Controller.

### Warranty Information

ClimateMaster residential class heat pumps are backed by a ten-year limited warranty on all unit parts, including the following accessories when installed with ClimateMaster units: Flow Controllers, Thermostats & Electric Heaters.

ClimateMaster goes even further to back up its commitment to quality by including a service labor allowance for the first five years on unit parts and thermostats, auxiliary electric heaters and geothermal pumping modules.

See ClimateMaster's 2010 Limited Express Residential Warranty Certificate RP851 for specific coverage and limitation.

The Optional Extended Factory Service Labor Allowance Warranty offers additional length of term protection to the consumer by offsetting service labor costs for 10 years.

To order this warranty, contact your ClimateMaster distributor. This coverage must be purchased within 90 days of unit installation. See Limited Express Extended Labor Warranty Certificate RP852 for details.





## Revision History

Date	Page #	Description
27 Apr. 23	All	Transitioned from DXM2 to DXM2.5 unit controls. Introduced new Wi-Fi cloud connected color touch screen communicating thermostat
11 Nov. 22	Various	Added ClimaDry Reheat
20 May, 21	41	Updated Dimensions for "O" and "P"
24 Aug, 20	49	Updated warranties
8 Nov. 19	5	Removed no flow center graphic
29 Oct. 19	6, 10	Decoder and pump curve updates
17 Sept. 19	17	Updated EER and HR
23 Jan. 19	4,43	High Head Variable Pump update
21 Aug. 18	11	Update TE026
15 Nov. 17	3	Updated Energy Star logo
27 Jan. 17	Various	Removed Federal Tax Incentive reference
30 Mar. 16	8 & 9	Run test description
9 Feb, 16	52	Updated certification logos
17 Dec., 15	Various	Added "Optional" to vFlow
17 July, 15	29-31	Updated WPD data
11 Feb., 15	36, 43	Updated Max Pressure, Add External Pump to Electrical Data
23 Oct., 14	26-35	Performance Data Updated
02 Oct., 14	All	Updated for No vFlow® Option
28 July, 14	16-25	Updated Water Pressure Drop Data
14 July, 14	All	Updated to Rev. B
10 Aug., 12	27, 29, 32	'Located on Air Coil Side' Note Added to Drawing
8 May, 12	All	First Published



A NIBE GROUP MEMBER

7300 S.W. 44th Street  
Oklahoma City, OK 73179

Phone: 405-745-6000

Fax: 405-745-6058

climatemaster.com

ClimateMaster works continually to improve its products. As a result, the design and specifications of each product at the time for order may be changed without notice and may not be as described herein. Please contact ClimateMaster's Customer Service Department at 1-405-745-6000 for specific information on the current design and specifications. Statements and other information contained herein are not express warranties and do not form the basis of any bargain between the parties, but are merely ClimateMaster's opinion or commendation of its products.

Engineered and assembled in the USA

© ClimateMaster, Inc. 2012